



CS50 Software Industrial Protocol Manual

v8.0.1, October 2016

Copyright ©2016

All rights reserved. The information contained herein is proprietary and is provided solely for the purpose of allowing customers to operate and/or service di-soric manufactured equipment and is not to be released, reproduced, or used for any other purpose without written permission of di-soric.

Throughout this manual, trademarked names might be used. We state herein that we are using the names to the benefit of the trademark owner, with no intention of infringement.

Disclaimer

The information and specifications described in this manual are subject to change without notice.

Contents

PREFACE	Welcome v Purpose of This Manual v Manual Conventions v
CHAPTER 1	Enabling Industrial Protocols 1-1 Enabling Protocols for the CS50 Sensor 1-2
CHAPTER 2	Using EtherNet/IP 2-1 EtherNet/IP for the CS50 Sensor 2-2 Assembly Layout 2-4 Connection Properties: Class 3 Explicit Messaging 2-14 EtherNet/IP Control/Status Signal Operation 2-17 Data Type Descriptions and Equivalents in PLC and EDS/CIP Environments 2-18 PLC Tags and Serial Command Names 2-19
CHAPTER 3	Allen-Bradley AOI (Add-On Instructions) for EtherNet/IP Operation 3-1 Rockwell RSLogix 5000 AOI (Add-On Instructions) for di-soric Devices 3-2
CHAPTER 4	Allen-Bradley PLC Setup via EDS for EtherNet/IP Operation 4-1 AB Rockwell RSLogix 5000 v20 PLC Integration with EDS 4-2
CHAPTER 5	Allen-Bradley PLC Setup via Generic Ethernet Module for EtherNet/IP Operation 5-1 Integrating the Camera into a PLC Environment 5-2
CHAPTER 6	Demo EtherNet/IP PLC Code 6-1 Glossary of Terms 6-2 Demo Setup 6-3

	Description of PLC Tags 6-6
	Run the Camera: Runtime Operation of EtherNet/IP Demo 6-16
CHAPTER 7	Omron PLC Setup for EtherNet/IP Operation 7-1
	Setting Up an Omron PLC 7-2
CHAPTER 8	Using PROFINET I/O 8-1
	CS50 Sensor PROFINET I/O 8-2
	Slot Data Layout Diagrams 8-5
	STEP 7 PLC Slot Layout 8-8
CHAPTER 9	PROFINET I/O Blob Count Demo Using TIA Portal V13 and CS50 Sensor 9-1
	Overview 9-2
	Troubleshooting 9-23
CHAPTER 10	PROFINET I/O Circle Locate Demo Using TIA Portal V13 and CS50 Sensor 10-1
	Overview 10-2
	Troubleshooting 10-24
CHAPTER 11	PROFINET I/O Blob Count Demo Using STEP 7 and CS50 Sensor 11-1
	Overview 11-2
	CS50 Software Setup 11-3
	STEP 7 Setup 11-6
CHAPTER 12	PROFINET I/O Circle Locate Demo Using STEP 7 and CS50 Sensor 12-1
	Overview 12-2
	CS50 Software Setup 12-3
	STEP 7 Setup 12-7

Welcome

Purpose of This Manual

This manual contains detailed information about how to configure and deploy EtherNet/IP and PROFINET I/O-based applications using CS50 Software and the CS50 Sensor.

Manual Conventions

The following typographical conventions are used throughout this manual.

- Items emphasizing important information are **bolded**.
- Menu selections, menu items and entries in screen images are indicated as: Run (triggered), Modify..., etc.

Enabling Industrial Protocols

This section describes how to enable EtherNet/IP for the CS50 Sensor, and how to switch the CS50 Sensor's protocol between EtherNet/IP and PROFINET I/O.

Enabling Protocols for the CS50 Sensor

CS50 Software – CS50 Sensor

In the **Connect** view, and with a CS50 Sensor selected, click the button to the left of **Details** (directly below the image of the CS50 Sensor) to view camera settings. Click **Modify** at the bottom of the dialog to change camera settings. Select the desired protocol from the **Industrial Protocol** dropdown menu, and then click **Apply** at the bottom of the dialog.

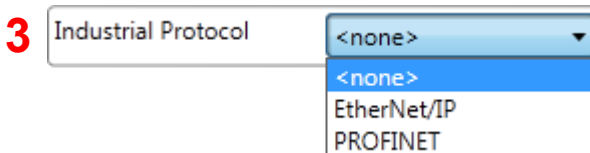
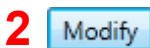
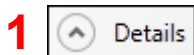

You will see the **Reboot Required** dialog after clicking Apply.

Note: A change to Industrial Protocol requires a reboot of the camera before the new setting can take effect.

Choose **Yes** and the camera will be rebooted for you. CS50 Software will be disabled while the reboot is in process. If you choose **No**, the change will not take effect until you manually reboot the camera.

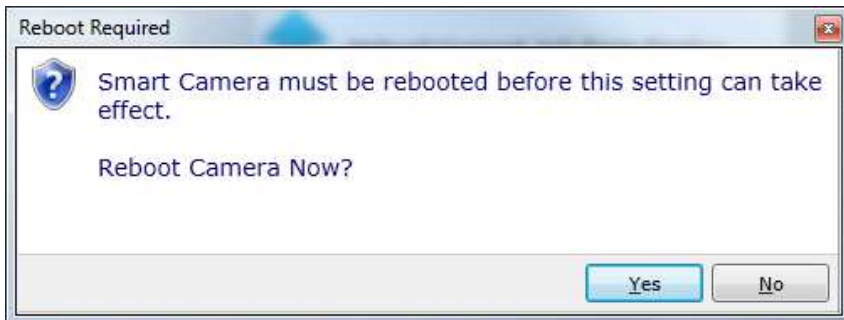

Using EtherNet/IP

This section provides information necessary for using the CS50 Sensor in an EtherNet/IP environment.

Notes:

- The camera communications protocol must be enabled for EtherNet/IP before it can be used in this environment. Refer to **Chapter 1, [Enabling Industrial Protocols](#)**, for information about enabling communications protocols for the CS50 Sensor, and information about switching CS50 Sensor communications protocols.
- CS50 Software jobs use di-soric Link functionality to accommodate EtherNet/IP communications between the camera and the PLC. For information about how to connect job parameters and outputs to di-soric Link tags, refer to the **di-soric Link** section of *CS50 Software Help*.

EtherNet/IP for the CS50 Sensor

Overview

The EtherNet/IP interface will be identified as Vendor Specific (100). The interface is designed to support Class 1 Implicit I/O data exchange, and Class 3 Explicit messages for serial commands not accessible with Implicit messaging.

Necessary Tools

The following tools are helpful for configuring EtherNet/IP:

- CS50 Software
- EtherNet/IP Messaging Tool – can be a PLC or Software Tool, must be capable of sending explicit messages and establishing Class 1 connections. EIPScan from Pyramid Solutions is an example of such a tool.
- Terminal emulation or serial communication tool that can connect to serial uart and TCP socket, such as HyperTerminal or Putty.

EtherNet/IP Terms of Use

EtherNet/IP Technology is governed by the Open DeviceNet Vendor Association, Inc (ODVA). Any person or entity that makes and sells products that implement EtherNet/IP Technology must agree to the Terms of Usage Agreement issued by ODVA. See www.odva.org for details.

EtherNet/IP Object Model

The CS50 Sensor uses Class 1 connected messaging to communicate most of its data and services in a single connection.

EtherNet/IP Identity

Device Type

Device type is 100, Vendor Specific, Machine Vision Camera.

Vendor ID

di-soric's ODVA Vendor ID is 1095.

Product Code

The CS50 Sensor Product Code is 7000.

Interface Revision

Major.Minor = 1.1

Connection Properties: Class 1 Implicit Messaging

Input Assembly Instance (to PLC/client): 102

Output Assembly Instance (to camera): 114

Size: Fixed, 320 bytes in both directions

Input Trigger/Trigger Mode: Cyclic

RPI (Requested Packet Interval): Greater than 20 ms recommended. 10 ms to 3.2 s allowed.

Input Type/Connection Type:

- Point-to-Point (PLC OUT, O > T)
- Point-to-Point (PLC IN, T > O)

Connection Priority: Scheduled

Assembly Layout

Input Assembly

The **input assembly** layout is described below.

Bytes	Name	Description
0...1	STATUS	Status register of the camera, each bit of this register represents a different state item. See Camera Status Register for bit descriptions
2...3	ECHO	This 16 bit word value reflects back to the PLC the value that the PLC wrote to the output assembly ECHO register. The PLC can verify the output assembly has been written to the camera when this value matches the written value.
4...7	CmdCodeRslt	When Status.ExeCmdAck goes active in response to Control.ExeCmd, CmdCodeRslt reflects the result of the command invoked by Control.CmdCode. See CmdCodeRslt for definitions.
8...11	CmdRet	When Status.ExeCmdAck goes active in response to Control.ExeCmd, CmdRet contains the data returned from the command invoked by Control.CmdCode. See CmdRet for definitions.
12...13	reserved	Reserved for future use.
14...15	State	Device State register. Depending on the current state of the camera, certain STATUS and CONTROL features may or may not be operational. See State for definitions.
16...17	VIO	Each bit reflects the state of a virtual IO point. The least significant bit reflects vio point 145, the most significant bit vio point 160
18...19	reserved	Reserved for future use.
20...27	bool1-64	Each bit represents a bool value. The least significant bit of byte 20 reads the value of bool1. The most significant bit of byte 27 reads bool64.
28...47	int1-10	Each pair of sequential bytes represents a 16 bit signed integer value. The 20 bytes represent 10 integers. From bytes 28 & 29 for the value of int1 through bytes 46 & 67 for the value of int10.
48...87	long1-10	Each group of 4 bytes represents a 32 bit signed integer value. The 40 bytes represent 10 long integers. From bytes 48-51 for the value of long1 through bytes 84-87 for the value of long10.
88...127	float1-10	Each group of 4 bytes represents a floating point value. The 40 bytes represent 10 floating point values. From bytes 88-91 for the value of float1 through bytes 124-127 for float10.
128...223	string1	These 96 bytes can store a string of up to 92, 8 bit characters, with the first 4 bytes containing the length value.
224...255	string2	Each of these 32 byte groups can store a string of up to 28, 8 bit characters, with the first 4 bytes containing the length value.
256...287	string3	
288...319	string4	

The input assembly layout is shown here:

Byte		Byte		Byte		Byte		Byte
0	STATUS	64	long5	128		192		256
2	ECHO	66		130		194		258
4	CMD CODE RSLT	68	long6	132		196		260
6		70		134		198		262
8	CMD RET	72	long7	136		200		264
10		74		138		202		266
12	reserved	76	long8	140		204		268
14	STATE	78		142		206	string1	270
16	VIO	80	long9	144		208	(cont)	272
18	reserved	82		146		210		274
20	bool1...16	84	long10	148		212		276
22	bool17...32	86		150		214		278
24	bool33...48	88	float1	152		216		280
26	bool49...64	90		154		218		282
28	int1	92	float2	156		220		284
30	int2	94		158	string1	222		286
32	int3	96	float3	160		224		288
34	int4	98		162		226		290
36	int5	100	float4	164		228		292
38	int6	102		166		230		294
40	int7	104	float5	168		232		296
42	int8	106		170		234		298
44	int9	108	float6	172		236		300
46	int10	110		174		238	string2	302
48	long1	112	float7	176		240		304
50		114		178		242		306
52	long2	116	float8	180		244		308
54		118		182		246		310
56	long3	120	float9	184		248		312
58		122		186		250		314
60	long4	124	float10	188		252		316
62		126		190		254		318

Status: Camera Status Register (16-bit)

Each bit of this register represents a different state of the camera's operation. A high value of 1 indicates that state is active (true).



Bit	Name	Description
0	ONLINE	Inspections are running
1	EXP BUSY	The camera is busy capturing an image. The camera should not be triggered or the part under inspection moved during this time if illuminated.
2	ACQ BUSY	The camera is busy acquiring an image. The camera cannot be triggered while busy.
3	TRIGGER READY	The camera is ready to be triggered. This is equivalent to <code>ONLINE == 1</code> and <code>ACQ BUSY == 0</code> .
4	ERROR	An error has occurred. Set the RESET ERROR control bit high to clear.
5	RESET COUNT ACK	This bit mirrors the RESET COUNT control bit. The PLC can be certain the reset command was received by the camera when this goes high. The PLC can then bring the RESET COUNT control signal back low.
7	EXE CMD ACK	This bit mirrors the EXE CMD control bit.
8	TRIGGER ACK	This bit mirrors the TRIGGER control bit.
9	INSP BUSY	This bit is high when inspection 1 is busy processing an image.
10	INSP STAT	This bit represents the inspection 1 status result. It is 1 if the inspection passes. It is only valid when DataValid goes high.
11	DATA VALID	This bit goes high when inspection 1 is complete. The PLC should clear this signal by setting RESET DV high once it has read results.

CmdCodeRslt (32-bit)

The value of **CmdCodeRslt** is only valid when **ExeCmdAck** is active (1), in response to **ExeCmd** being active.

CmdCodeRslt value (base 16 hex)	Meaning
0x0000_0000	Success
0x0100_0000	Fail. Possible reasons: Camera under PC control. Job cannot be changed.
0x0200_0000	Fail: No Job in slot.
0x0300_0000	Fail: Unknown cmd.

CmdRet (32-bit)

The value of **CmdRet** is only valid when **ExeCmdAck** is active (1), in response to **ExeCmd** being active, and **CmdCodeRslt** is **0 (Success)**. The following table shows which CmdCodes return data in the CmdRet register.

CmdRet value (32 bit)	Associated CmdCode	Meaning
0	0x1000_0000 to 0x1300_0000 (Job Change type)	Na
1 – 255	0x1800_0000 (Query Active Job Slot)	Active Job Slot #

State (16-bit)

State reflects the following operational condition of the camera:

State value (16 bit)	Meaning	Typical action required by the client (plc), or system operator
----------------------	---------	---

0	Offline	Perform job change or put camera online.
1	Online	Normal runtime operation: Monitor TriggerReady and DataValid signals. Trigger the camera.
2	Changing Vision Job	If camera is under pc control: Wait until State changes to Offline or Online. If plc is controlling the job change: Use ExeCmd, CmdCode, ExeCmdAck, and CmdCodeRslt to complete the operation.
3	Booting*	Wait for camera to transition to Online or Offline.
4	Empty (no Vision Job)	Load a new job from AutoVISION or Front Runner.

*Booting (3) State: This will rarely be seen by the PLC.

The value of State determines which **Control** and **Status** signals are available:

Control/Status Signal	State				
	0 (Offline)	1 (Online)	2 (Job Change)	3 (Booting)	4 (Empty)
Control.GO ONLINE	Y				
“.GO OFFLINE		Y			
“.RESET ERROR					
“.RESET COUNT	Y	Y			
“.EXE CMD	Y	Y	Y		Y
“.TRIGGER		Y			
“.RESET DATA VALID		Y			
Status.ONLINE	Y	Y	Y	Y	Y
“.ERROR					
“.RESET COUNT ACK	Y	Y			
“.EXE CMD ACK	Y	Y	Y		Y
“.EXP BUSY		Y			
“.ACQ BUSY		Y			
“.TRIGGER READY		Y			
“.TRIGGER ACK		Y			
“.INSP BUSY		Y			
“.INSP STAT		Y			
“.DATA VALID		Y			

Where:

Y = Signal is valid for this State

Empty table cell = Signal is not valid for this State

VIO Register Bits

15	14	13	12	11	10	9	8	7	6	5	4	3	2	1	0
v160	v159	v158	v157	v156	v155	v154	v153	v152	v151	v150	v149	v148	v147	v146	v145

Output Assembly

The **output assembly** layout is described below and shown in the following diagram.

Bytes	Name	Description
0...1	CONTROL	Control register of camera. Each bit of this register represents a different status item. See Camera Control Register for bit descriptions
2...3	ECHO	This 16 bit value is reflected back to the PLC in the input assembly ECHO register. The PLC can verify the output assembly has been written to the camera when the input assembly matches this written value.
4...7	CmdCode	Specifies the process invoked in the camera when Control.ExeCmd goes active. See CmdCode for definitions.
8...11	CmdArg	Additional argument data for the CmdCode. See CmdArg for definition.
12...15	reserved	Reserved for future use.
16...17	VIO	Each bit reflects the state of a virtual IO point. The least significant bit reflects vio point 129, the most significant bit is vio point 144
18...19	Reserved	Reserved for future use.
20...27	bool	Each bit represents a bool value. The least significant bit of byte 20 writes the value of bool101. The most significant bit of byte 27 writes bool164.
28...47	int101-110	Each pair of sequential bytes represents a 16 bit signed integer value. The 20 bytes represent 10 integers. From bytes 28 & 29 to write the value of int101 through bytes 46 & 67 for the value of int110.
48...87	long101-110	Each group of 4 bytes represents a 32 bit signed integer value. The 40 bytes represent 10 long integers. From bytes 48-51 for the value of long101 through bytes 84-87 for the value of long110.
88...127	float101-110	Each group of 4 bytes represents a floating point value. The 40 bytes represent 10 floating point values. From bytes 88-91 for the value of float101 through bytes 124-127 for the value of float110.
128...223	string101	These 96 bytes can store a string of up to 92 bytes, with the first 4 bytes containing the length value.
224...255	string102	Each of these 32 byte groups can store a string of up to 28 bytes, with the first 4 bytes containing the length value.
256...287	string103	
288...319	string104	

The output assembly layout is shown here:

Byte		Byte		Byte		Byte		Byte
0	CONTROL	64	long105	128		192		256
2	ECHO	66		130		194		258
4	CMD CODE	68	long106	132		196		260
6		70		134		198		262
8	CMD ARG	72	long107	136		200		264
10		74		138		202		266
12	reserved	76	long108	140		204		268
14		78		142		206	string101	270
16	VIO	80	long109	144		208	(cont)	272
18	reserved	82		146		210		274
20	bool101_116	84	long110	148		212		276
22	bool117_132	86		150		214		278
24	bool133_148	88	float101	152		216		280
26	bool149_164	90		154		218		282
28	int101	92	float102	156		220		284
30	int102	94		158		222		286
32	int103	96	float103	160	string101	224		288
34	int104	98		162		226		290
36	int105	100	float104	164		228		292
38	int106	102		166		230		294
40	int107	104	float105	168		232		296
42	int108	106		170		234		298
44	int109	108	float106	172		236		300
46	int110	110		174		238		302
48	long101	112	float107	176		240	string102	304
50		114		178		242		306
52	long102	116	float108	180		244		308
54		118		182		246		310
56	long103	120	float109	184		248		312
58		122		186		250		314
60	long104	124	float110	188		252		316
62		126		190		254		318

Control: Camera Control Register (16-bit)

Each bit of this register controls a function on the camera. Transitions from a low state of **0** to a high state of **1**, initiates the associate operation. The PLC should return the state of the control bit back to **0** after it has acknowledged the camera has processed the control. Unused bits should remain **0**.

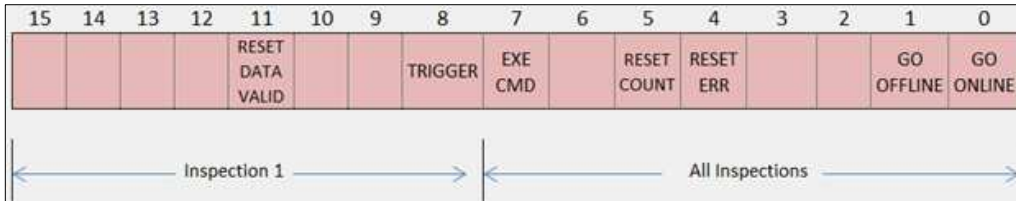

Bit	Name	Description
0	GO ONLINE	Start all inspections running
1	GO OFFLINE	Stop all inspections
4	RESET ERROR	Reset ERROR in the Status register
5	RESET COUNT	Reset all inspection counts
7	EXECMD	Execute the command specified by Control.CmdCode
8	TRIGGER	Trigger Inspection 1. The inspection must be configured for a triggered image acquisition.
11	RESET DATA VALID	Reset the Data Valid signal of the Status register

CmdCode and CmdArg (32-bit)

Specifies the process invoked in the camera when **Control.ExeCmd** goes active.

List of available CmdCodes, and associated CmdArg:

CmdCode value	CmdArg	Operations performed
0x1000_0000	Job Slot (1-255)	Go Offline, Load job from specified slot
0x1100_0000	Job Slot (1-255)	Go Offline, Load job from specified slot, Go Online
0x1200_0000	Job Slot (1-255)	Go Offline, Load job from specified slot, Make it the boot job
0x1300_0000	Job Slot (1-255)	Go Offline, Load job from specified slot, Make it the boot job, and Go Online
0x1800_0000	na	Query active job slot. CmdRet will contain the active job slot number when the operation is done.

CmdCode and ExeCmd Operation

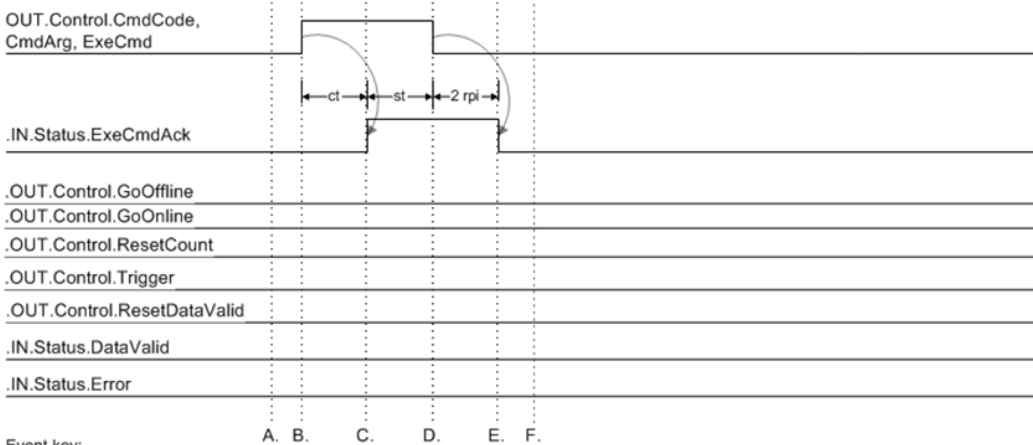

Event key:

- A. If DataValid or Error are present, clear them.
 - Set the following control signals idle, and keep them idle while the command is processed by the camera: GoOffline, GoOnline, Trigger, ResetDataValid, ResetCount, ResetError.
- B. Populate CmdCode and CmdArg, then activate ExeCmd.
- C. Camera executes the command (may take up to a minute). While processing a Job Change command, State will be 2. Camera activates ExeCmdAck when it is done processing the command.
- D. When the PLC sees an active ExeCmdAck, verify CmdCodeRslt is 0, and Error is 0. Process CmdRet if needed, then clear ExeCmd.
- E. Camera clears ExeCmdAck when ExeCmd goes inactive. When ExeCmdAck goes inactive, CmdCodeRslt and CmdRet are no longer valid, and it may take a few seconds for the camera State and Online signals to settle to a final value (typically Online or Offline).
- F. Camera can now be put online and triggered.

Notes:

st = PLC program scan time
 ct = Command processing time in the camera. May take up to a minute for some commands.
 rpi = Requested Packet Interval. Configured in the plc's EIP module connection properties. Allowed rpi is 10 ms to 3.2 s.
 All signals represent the state of plc tags.

VIO Register Bits

15	14	13	12	11	10	9	8	7	6	5	4	3	2	1	0
v144	v143	v142	v141	v140	v139	v138	v137	v136	v135	v134	v133	v132	v131	v130	v129

Connection Properties: Class 3 Explicit Messaging

All Class 1 I/O assembly data and additional data are accessible via Explicit message. Input data (camera to PLC/Client) occupies attributes **1** to **100** of the classes. Output data (PLC/Client to camera) occupies attributes **101** to **200**.

Service:

- Get Attribute Single (0xE)
- Set Attribute Single (0x10)

Classes:

- bool = 104 (0x68)
- int = 105 (0x69)
- long = 106 (0x6A)
- float = 107 (0x6B)
- string = 108 (0x6C)
- control/status (mixed data types) = 109 (0x6D)

Instance: 1

Attribute:

- 1 to 100 = In to PLC/Client
- 101 to 200 = Out to Camera

Attribute Layout

When using explicit EtherNet/IP messaging, all global data objects can be read or written. Each data type is stored in its own class object and an instance of 1 to read the global data. For example, to read **float2**, the EtherNet/IP request would be for **Service Code 14 (0xE), Class 107 (0x6B), Instance 1, Attribute 2**.

Class 104		Class 105		Class 106		Class 107		Class 108		Class 109	
Attr#		Attr#		Attr#		Attr#		Attr#		Attr#	
1	bool1	1	int1	1	long1	1	float1	1	string1	1	CONTROL
2	bool2	2	int2	2	long2	2	float2	2	string2	2	STATUS
3	bool3	3	int3	3	long3	3	float3	3	string3	3	
4	bool4	4	int4	4	long4	4	float4	4	string4	4	
5	bool5	5	int5	5	long5	5	float5	5	string5	5	
6	bool6	6	int6	6	long6	6	float6	6	string6	6	ECHO
7	bool7	7	int7	7	long7	7	float7	7	string7	7	CMD CODE
8	bool8	8	int8	8	long8	8	float8	8	string8	8	CMD ARG
9	bool9	9	int9	9	long9	9	float9	9	string9	9	CMD CODE RSLT
10	bool10	10	int10	10	long10	10	float10	10	string10	10	CMD RET
...	11	STATE
...
199	bool199	199	int199	199	long199	199	float199	199	string199	199	
200	bool200	200	int200	200	long200	200	float200	200	string200	200	

The value received in response to **Get Attribute Single** depends on the type:

- **Bool** will return a 16-bit word with **0** for false or **1** for true
- **Ints** will return a 16-bit signed integer
- **Longs** will return a 32-bit signed integer
- **Floats** will return a 32-bit floating point number
- **Strings** will return a counted string. Total size of a string data item is **2048 bytes**. This includes a 4 byte “length” field followed by 2044 eight bit characters. When accessing strings explicitly, they are not limited to the size in the I/O assemblies. For example, **string3** is limited to **28 bytes** in the input assembly. If the actual string is longer than 28 bytes, it will be truncated when reading via the assembly, but not truncated when reading the same string via an attribute explicitly.

Assembly Class 109 can be used to read and write special EtherNet/IP-specific registers.

Attr#	Name	Description
1	CONTROL	The control register (16 bit). See Camera Control Register for bit definitions.
2	STATUS	The status register (16 bit). See Camera Status Register for bit definitions.
6	ECHO	The ECHO register (16 bit) (read only if implicit write is enabled)
7	CMD CODE	The command code register (32 bit). See CmdCode .
8	CMD ARG	The command argument register (32 bit). See CmdArg .
9	CMD CODE RSLT	The command code result register (32 bit). See CmdCodeRslt .
10	CMD RET	The command return value register (32 bit). See CmdRet .
11	STATE	The device state register (16 bit). See State for definitions.

EtherNet/IP Control/Status Signal Operation

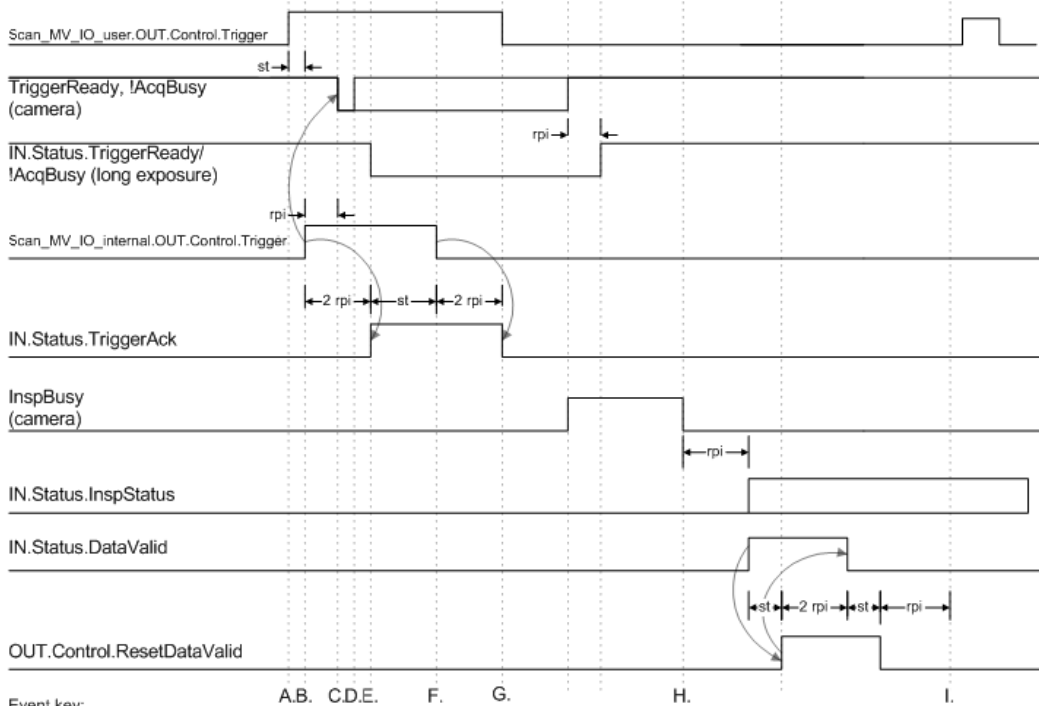

Event key:

- On rising edge of system trigger, the user app activates Scan_MV_IO_user.OUT.Control.Trigger to trigger the demo code.
- Demo code detects rising edge of Scan_MV_IO_user.OUT.Control.Trigger, and if the camera is ready, sends a trigger to the camera.
- Camera acquisition begins (may be delayed by one rpi).
- If the camera's exposure time is shorter than the rpi, no change will be seen in TriggerReady and AcqBusy plc IN tags.
- Camera firmware acks the trigger. The demo code may not see the ack until two rpi after the trigger was sent (event B).
- Demo code detects TriggerAck and clears the Trigger.
- Demo code detect falling edge of TriggerAck and clears the user Trigger.
- Camera internal signal DataValid will go high when InspBusy goes low
- Plc logic must delay one rpi time before re-asserting ResetDataValid

Notes:

- The chart shows the workings of the Trigger and ResetDataValid Control signals, and the TriggerAck and DataValid Status signals.
- st = plc program scan time
- rpi = Requested Packet Interval. Configured in the plc's EIP module connection properties. Allowed rpi is 10 ms to 3.2 s.
- All signals represent the state of plc tags, except where noted as "(camera)". The cam signals shown are visible in the EIP interface, but the state of the plc tags and internal firmware signals will be different for at least one or two requested packet intervals (rpi).
- The plc is running the demo code distributed with the camera. The demo code and user app use the Scan_MV_IO_user tag set as the primary control, status, and data interface for the user app. All signal operations are still true even if the plc demo code is not used.
- TriggerReady!/AcqBusy: Camera exposure times can range from less than 1 ms, up to 100 ms.

Data Type Descriptions and Equivalents in PLC and EDS/CIP Environments

AV	Description	RSLogix equivalent	Description	EDS/ EIP equivalents	Description
Bool	1 bit	BOOL	1 bit	BOOL	1 bit
				WORD	16 BOOLs
				LWORD	64 BOOLs
Int	16 bit signed integer	INT	16 bit signed integer	INT	16 bit signed integer
Long	32 bit signed integer	DINT	32 bit signed integer	DINT	32 bit signed integer
Float	32 bit floating point	REAL	32 bit floating point	REAL	32 bit floating point
String	32 bit length field followed by 8 bit ASCII characters	STRING	32 bit length field followed by 8 bit ASCII characters	DINT + USINT[]	DINT (length) + USINT array of characters. USINT = 8 bit integer

PLC Tags and Serial Command Names

PLC tags are separated into **IN** and **OUT** for data direction. Within the IN and OUT groups, the tags are sub-divided into fixed **Status** and **Control** fields, plus user-defined linked data fields. This table shows how PLC tag names correspond to serial commands.

IN			OUT		
PLC tag prefix	Serial cmd prefix	Tag name	PLC tag prefix	Serial cmd prefix	Tag name
IN.Status.	eip.status.	Online (1)	OUT.Control.	eip.control.	GoOnline ⁱ
IN.Status.	eip.status.	Online (0)	OUT.Control.	eip.control.	GoOffline ⁱⁱ
IN.Status.	eip.status.	Error	OUT.Control.	eip.control.	ResetError
IN.Status.	eip.status.	ResetCountAck	OUT.Control.	eip.control.	ResetCount
IN.Status.	eip.status.	TriggerAck	OUT.Control.	eip.control.	Trigger
IN.Status.	eip.status.	DataValid	OUT.Control.	eip.control.	ResetDataValid
IN.Status.	eip.status.	ExeCmdAck	OUT.Control.	eip.control.	ExeCmd
IN.Status.	eip.status.	TrigReady ⁱⁱⁱ	-	-	-
IN.Status.	eip.status.	AcqBusy	-	-	-
IN.Status.	eip.status.	ExpBusy	-	-	-
IN.Status.	eip.status.	InspBusy	-	-	-
IN.Status.	eip.status.	InspStat	-	-	-
IN.Status.	eip.	Echo	OUT.Control.	eip.	Echo
IN.Status.	eip.	CmdCodeRslt	OUT.Control	eip.	CmdCode
IN.Status	eip.	CmdRet	OUT.Control	eip.	CmdArg
IN.Status.	eip.	State	-	-	-
IN.vio.	io.	v[145-160]	OUT.vio.	io.	v[129-144]
IN.bool.	eip.	bool[1-100]	OUT.bool.	eip.	bool[101-200] ^{iv}
IN.int.	eip.	int[1-100]	OUT.int.	eip.	int[101-200] ^v
IN.long.	eip.	long[1-100]	OUT.long.	eip.	long[101-200]
IN.float.	eip.	float[1-100]	OUT.float.	eip.	float[101-200]
IN.string.	eip.	string[1-100]	OUT.string.	eip.	string[101-200]

ⁱ When GoOnline is changed from 0 to 1, Online goes to 1.

ⁱⁱ When GoOffline is changed from 0 to 1, Online goes to 0.

ⁱⁱⁱ TrigReady, AcqBusy, ExpBusy, InspBusy, and InspStat are all IN-direction data only.

^{iv} bool1-bool64 are mapped to PLC tags in the IN assembly. Bool101-bool164 are mapped to PLC tags in the OUT assembly. Bool members numbered 65-100 and 165-200 are accessible via Explicit Message only.

^v For int, long, float, and string data:

Data members numbered 1-10 are mapped to PLC tags in the IN assembly.

Data members numbered 101-110 are mapped to PLC tags in the OUT assembly.

Data members numbered 11-100 and 111-200 are accessible via Explicit Message only.

Allen-Bradley AOI (Add-On Instructions) for EtherNet/IP Operation

This section provides additional instructions helpful for using the CS50 Sensor in an EtherNet/IP environment.

Notes:

- The camera communications protocol must be enabled for EtherNet/IP before it can be used in this environment. Refer to **Chapter 1**, [Enabling Industrial Protocols](#), for information about enabling communications protocols for the CS50 Sensor, and information about switching CS50 Sensor communications protocols.
- CS50 Software jobs use di-soric Link functionality to accommodate EtherNet/IP communications between the camera and the PLC. For information about how to connect job parameters and outputs to di-soric Link tags, refer to the **di-soric Link** section of *CS50 Software Help*.

Rockwell RSLogix 5000 AOI (Add-On Instructions) for di-soric Devices

The AOI file has been created as basic instructions and as a main rung import. The AOI instructions read and write data when called. The main rung import has global tags and the AOI itself to demonstrate how the AOI is used for beginners with the RSLogix system. The AOI can be used with the EDS file.

Note: Examples in this section have been created using RSLogix 5000 version 20.

Steps

- Install EDS File
- Import AOI File
- Test Communications and Review Data

Install EDS File

In RSLogix 5000, select the **EDS Hardware Installation Tool** under the main menu **Tools**.

Click the **Next** button. Make sure the **Register an EDS Files(s)** radio button is selected.



Click the **Browse** button to locate the EDS file (C:\di-soric\Vscape\Firmware\eds). Once the EDS file is located and selected, click the **Next** button.

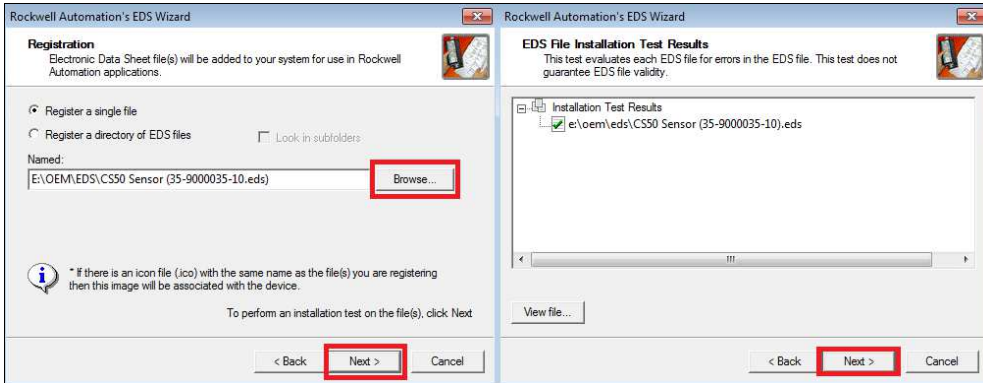

Click the **Next** button for the image. Click the **Next** button for the summary.

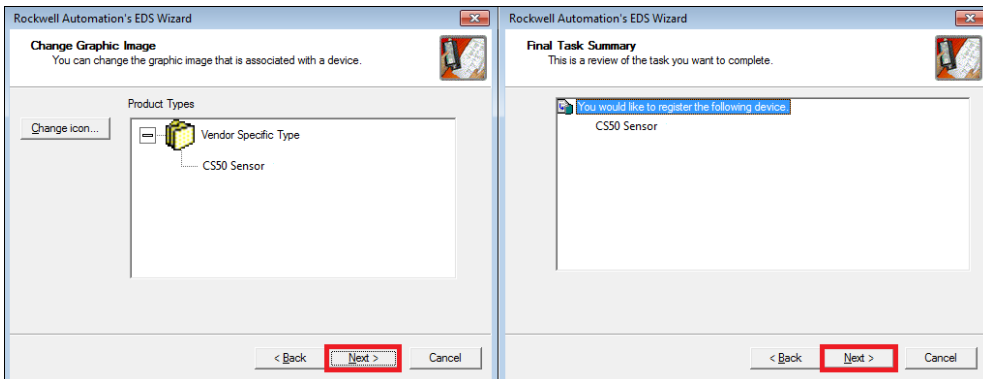

Click the **Finish** button to complete the EDS installation.

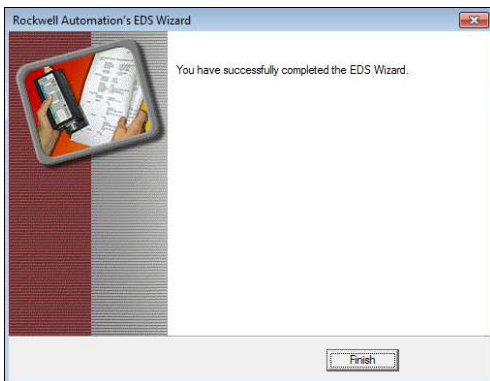

Right-click the Ethernet node on the left pane and select **New Module**. Enter the part number in the filter box to list the device. Select the device from the newly added EDS file. Double-click the device or select and click the **Create** button to add to the project.

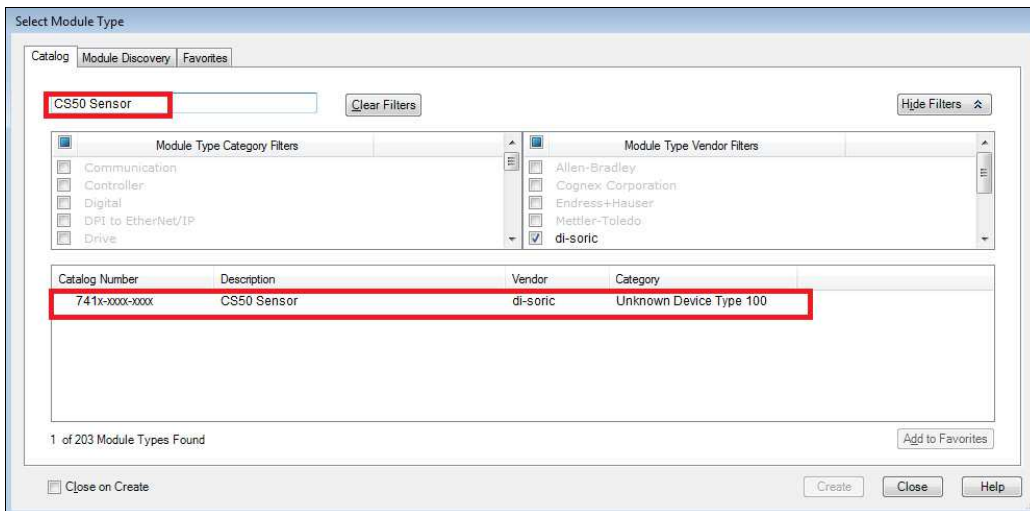

Enter the name for your device and the IP address, then click **OK**.

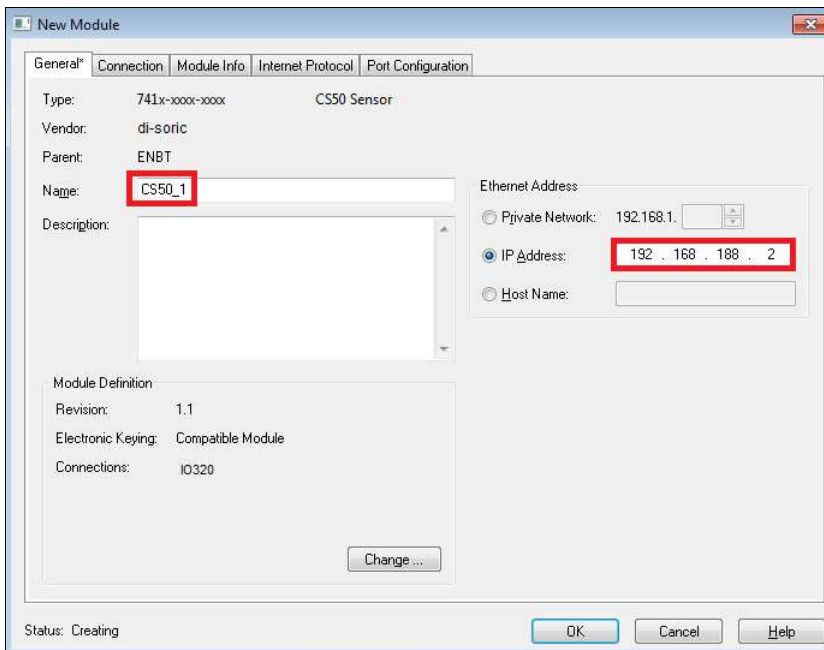

If the reader has multiple assembly sizes, the **Change** button allows you to select the other assembly formats.

Click the **Close** button on the module selection dialog to continue. Now the device has been added to the project and will be visible in the tree view under the **Ethernet** node.

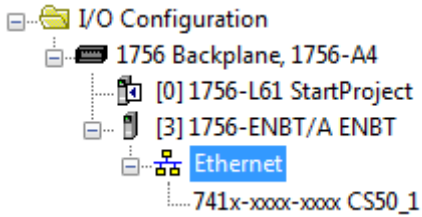

Import AOI File

Right-click the **Add-On Instructions** node in the tree view in the left pane and select **Import Add-On Instruction**. Locate the **L5X file** (C:\di-soric\Vscape\Firmware\aoi\) and click the **Import** button.

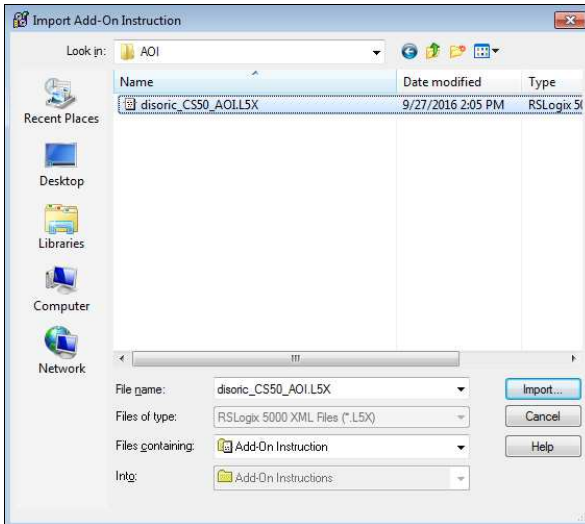

The **Import Configuration** dialog will prompt you for information regarding the AOI file. Select the **Data Types** to view the new tags and their attributes. Click **OK** when ready to continue.



New tags and logic will now be added to the project.

Test Communications and Review Data

After the reader module has been installed, you can start with a basic ladder logic program to test the data to and from the device. Two steps are involved to test the communication: (1.) Download an autovision job; (2.) Add logic to the PLC ladder logic.

Start by opening up CS50 Software and select the camera.

Select **Load a Job**.



Navigate to **di-soric > Vscope > Tutorials and Samples > EIP Demo > SimpleTrigger_Job.avp**.

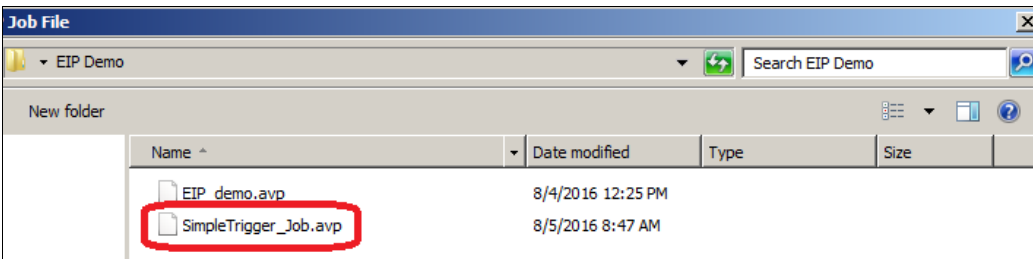

This job has not tools loaded and is a simple job that allows the PLC to trigger the camera. The user can also set another Trigger action in the Trigger panel on the right hand of the screen.



Now download the job to the camera by selecting the **Save Job to Camera** icon and selecting **New Slot**.

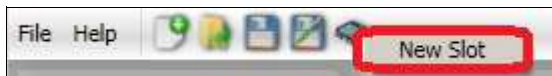

Select **Yes** to download the program to flash to the camera.

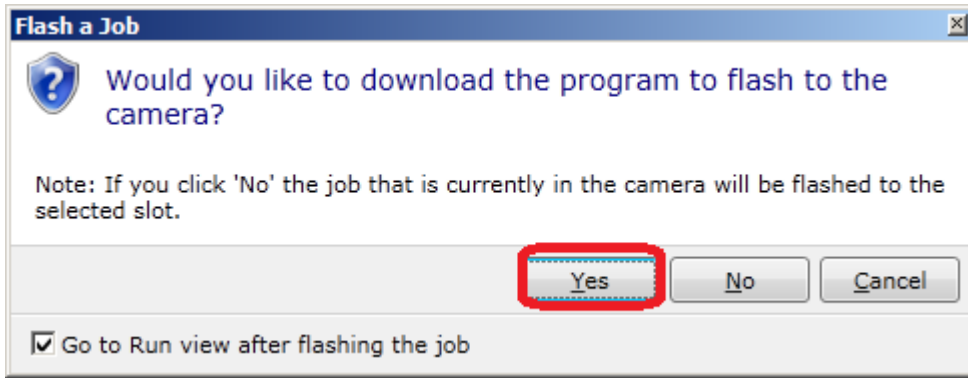

Next add the logic to the PLC. Do this by opening the **MainRoutine** editor and create an **Add-On-Instruction**.

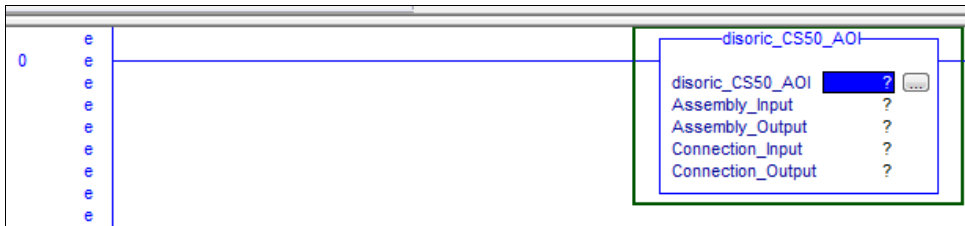

Right-click in the first element and create a **New Tag**.

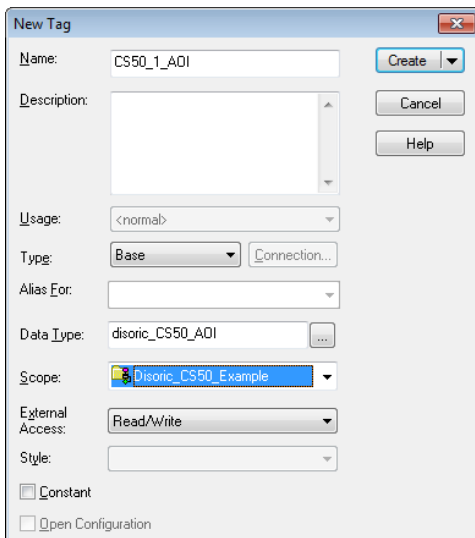

Right-click the second element and create a new tag for the **Assembly_Input**. It will default to the **AOI INPUT320** data type. Right-click the third element and create a new tag for the **Assembly_Output**. It will default to the **AOI OUTPUT320** data type.

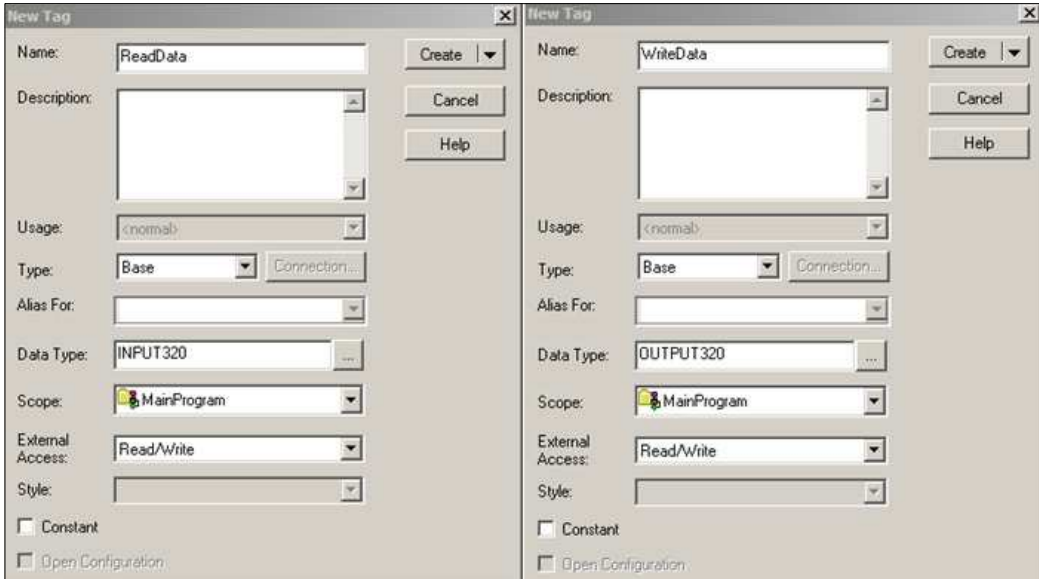

Double-click the fourth element and click the down arrow in the combo box to link the **Connection_Input** to the reader input data. The link should be the **[reader name]:I.Data**.

[-] CS50_1:I	_0447:741
[-] CS50_1:I.ConnectionFaulted	BOOL
[+] CS50_1:I.Data	SINT[320]

Note: Do not connect to the **ConnectionFault** item.

Double-click the fifth element and click the down arrow in the combo box to link the **Connection_Output** to the reader output data. The link should be the **[reader name]:O.Data**.

Name	Data Type
[+] CS50_1:I	_0447:741
[-] CS50_1:O	_0447:741
[+] CS50_1:O.Data	SINT[320]

Add a new rung by right-clicking and selecting **Add Rung**.

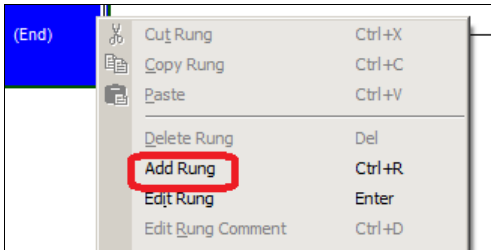

Create an **Examine On** trigger tag.

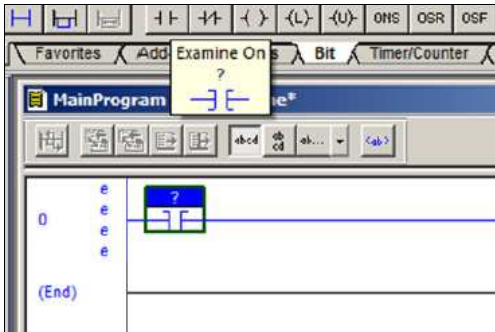

Right-click and create a **Boolean Trigger**.

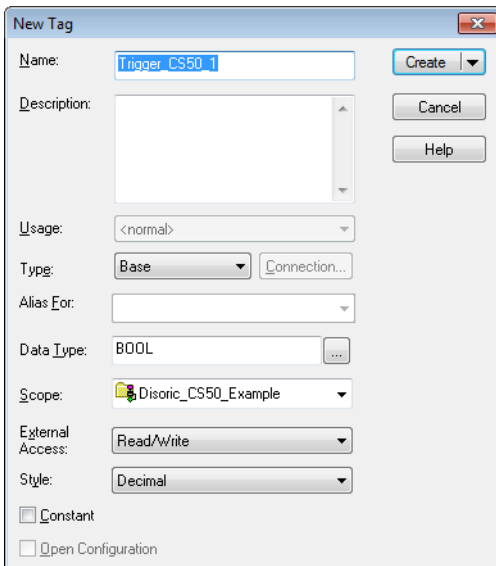

Add an **Output Engerized** tag to the end of the rung.

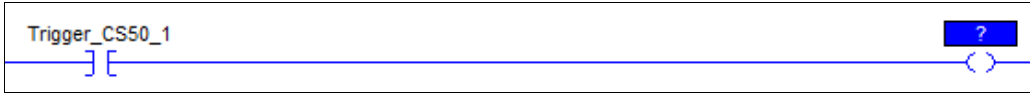

Assign the **Output Engerized** tag to the **WriteData.CONTROL.8** bit.

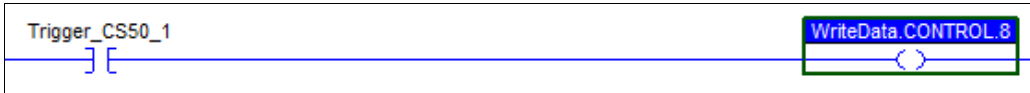

Now download the program to the PLC. Once the program has downloaded, set the PLC to **Run Mode**.

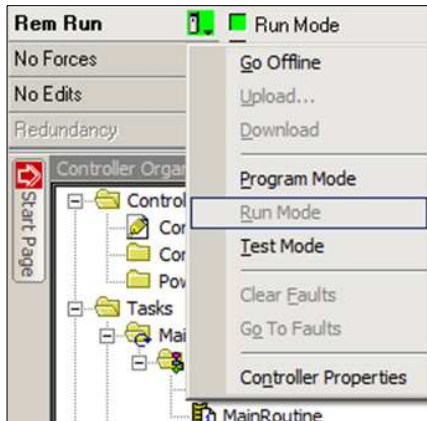

Note: Be sure the path to the PLC has been set in the project so that communications to the PLC can be established.

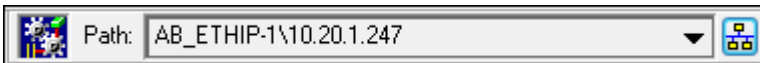

Toggle the bit Trigger by right-clicking and selecting **Toggle Bit** or by typing **Control + T**.

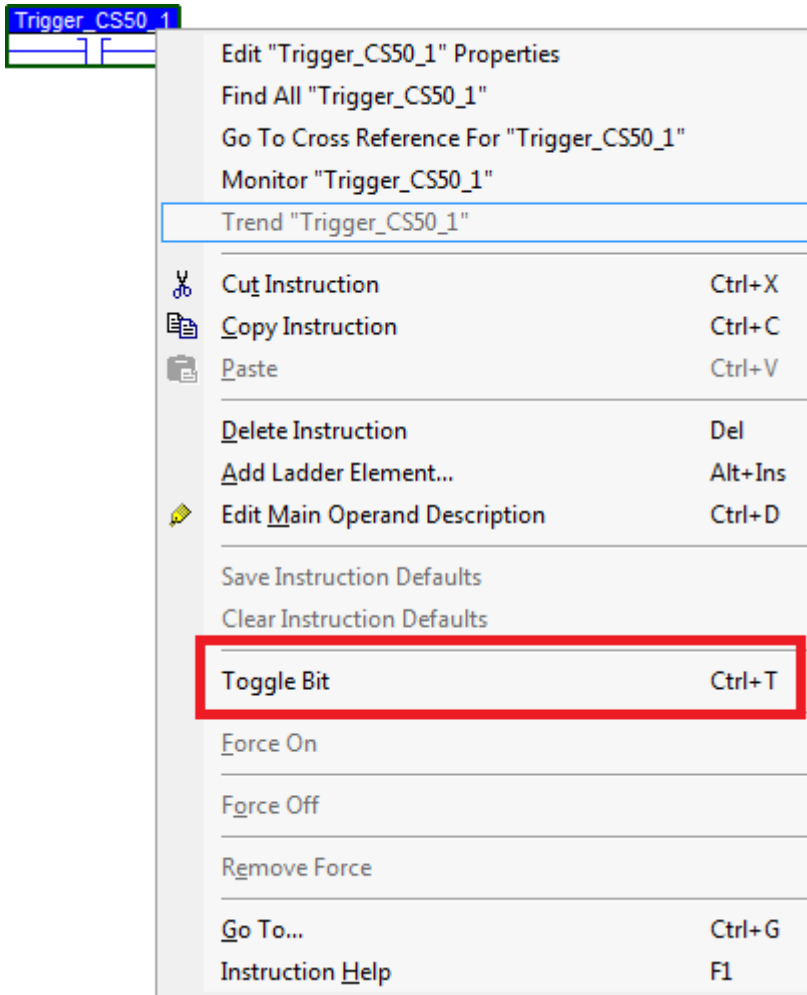

This action will set the Trigger tag high, causing the trigger output bit to go high in the Output Assembly. The camera will trigger on each rising edge (i.e. when the Trigger tag is set to 1). This will confirm that communication is established between the PLC and the camera.

Allen-Bradley PLC Setup via EDS for EtherNet/IP Operation

This section describes how to use an EDS file to set up an Allen-Bradley PLC for EtherNet/IP operation.

Notes:

- The camera communications protocol must be enabled for EtherNet/IP before it can be used in this environment. Refer to **Chapter 1**, [Enabling Industrial Protocols](#), for information about enabling communications protocols for the CS50 Sensor, and information about switching CS50 Sensor communications protocols.
- CS50 Software jobs use di-soric Link functionality to accommodate EtherNet/IP communications between the camera and the PLC. For information about how to connect job parameters and outputs to di-soric Link tags, refer to the **di-soric Link >** section of *CS50 Software Help*.

AB Rockwell RSLogix 5000 v20 PLC Integration with EDS

This section was created and run on the following Allen Bradley/Rockwell components:

- RSLogix 5000 Version 20.00.00 (CPR 9 SR 5)
- 756-L61 ControlLogix5561 Controller, firmware rev 20.11
- 1756-ENBT/A EtherNet/IP interface card, firmware rev 4.1

Run the Rockwell **EDS Hardware Installation Tool**.

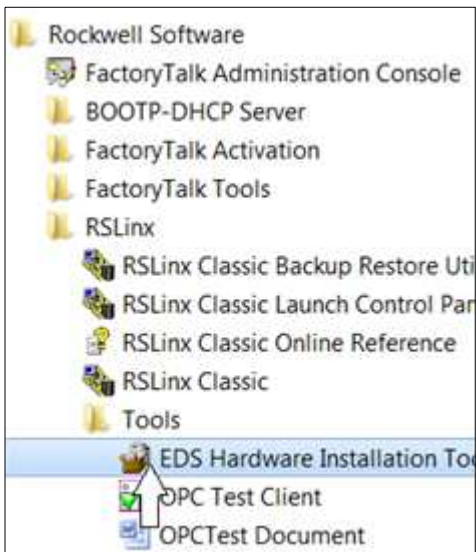

Select **Add**.

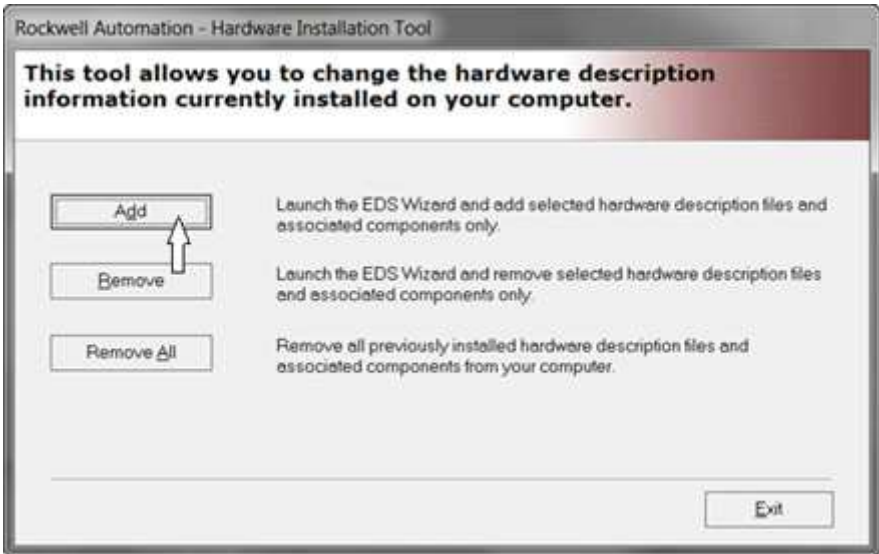

Select **Browse**.



Navigate to the CS50 Sensor EDS file, then **Open** it. The default install location is **C:\di-soric\Vscape\Firmware\eds\CS50**.

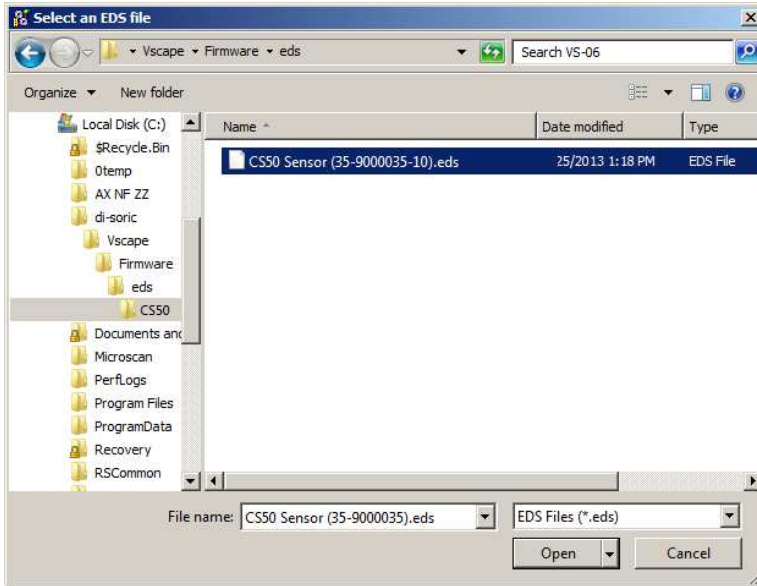

Keep clicking **Next** until the **Finish** button is displayed.

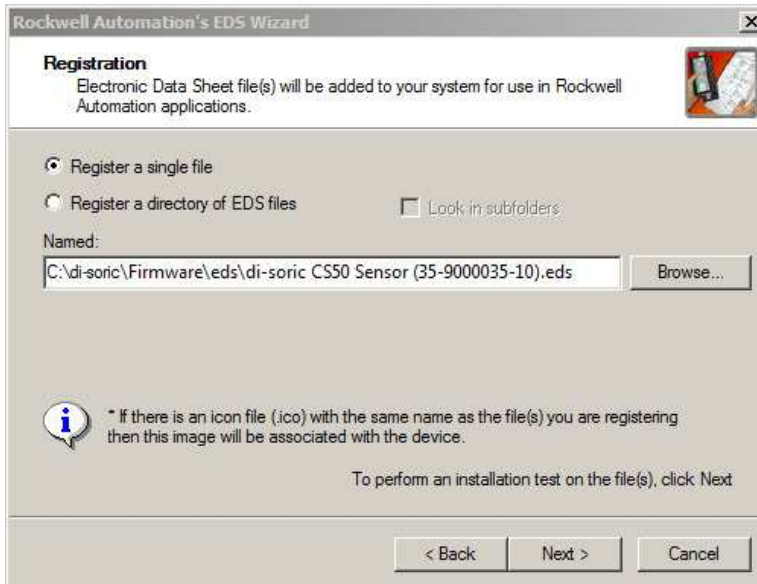

Click **Finish**.

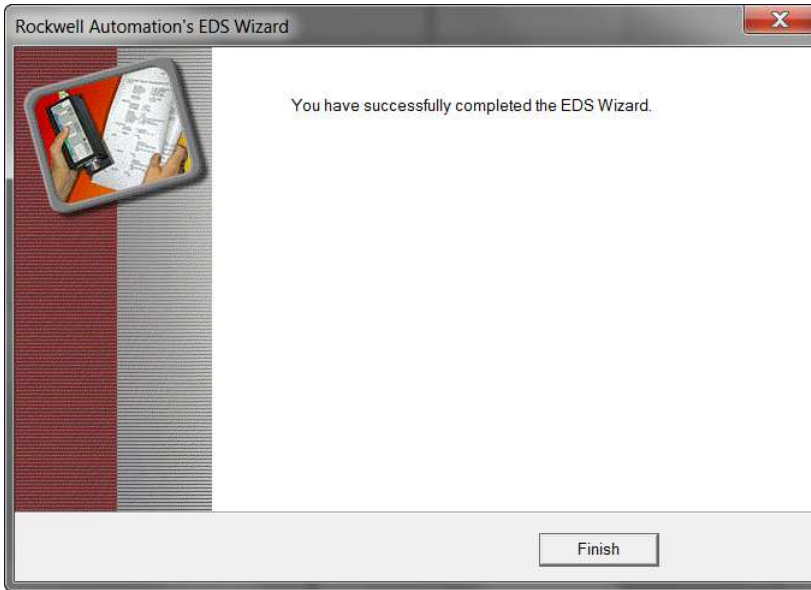

Open RSLogix 5000 v20 and create the **I/O Configuration** for the base system, including the system's Ethernet interface.

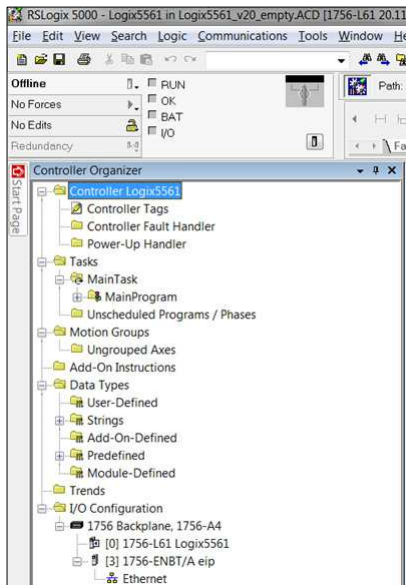

Right-click **Ethernet** and select **New Module**.

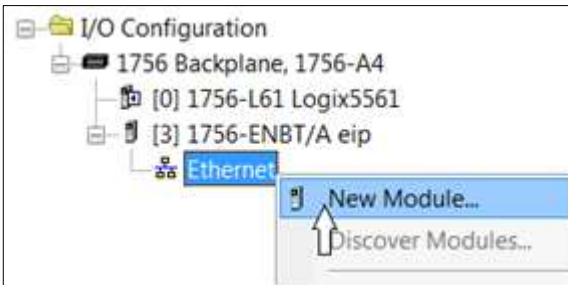

The **Select Module Type** dialog will be displayed.

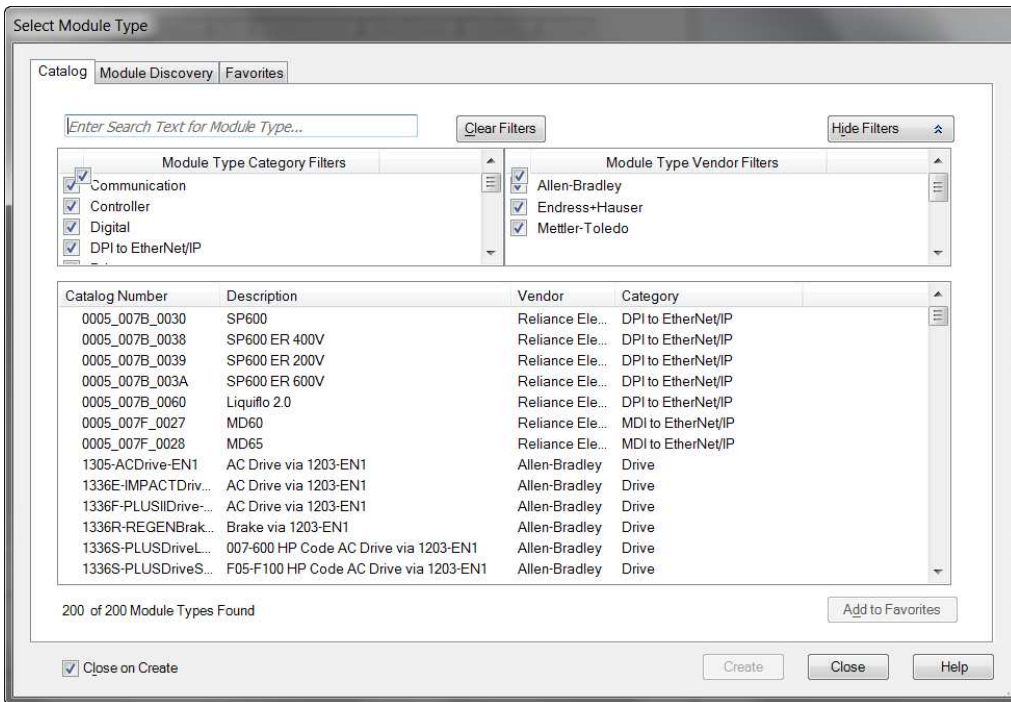

Clear the Module Type Vendor Filters.

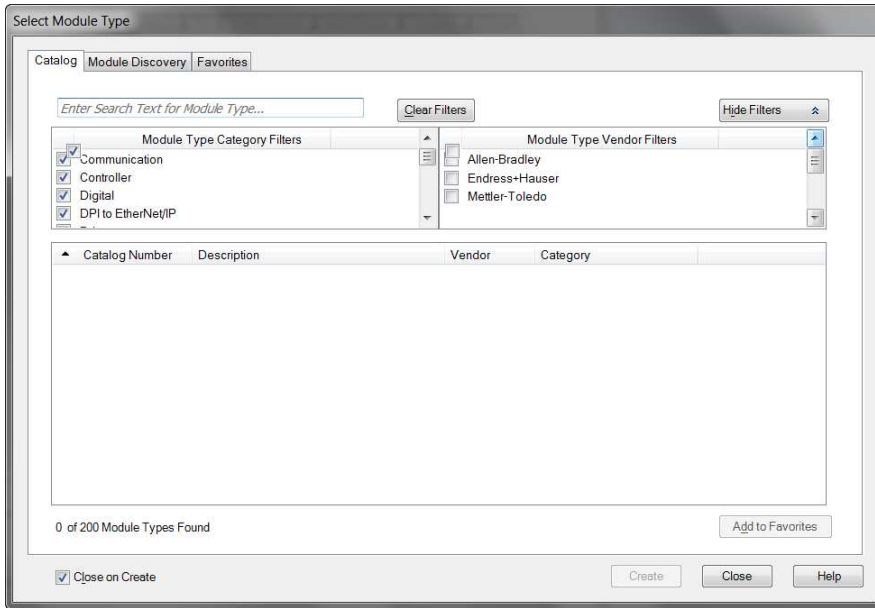

Scroll down the Module Type Vendor Filters until **di-soric** comes into view, then select di-soric.

Click the required camera and click **Create**.

The **New Module** dialog is displayed. Type a unique name for this camera and its IP address.

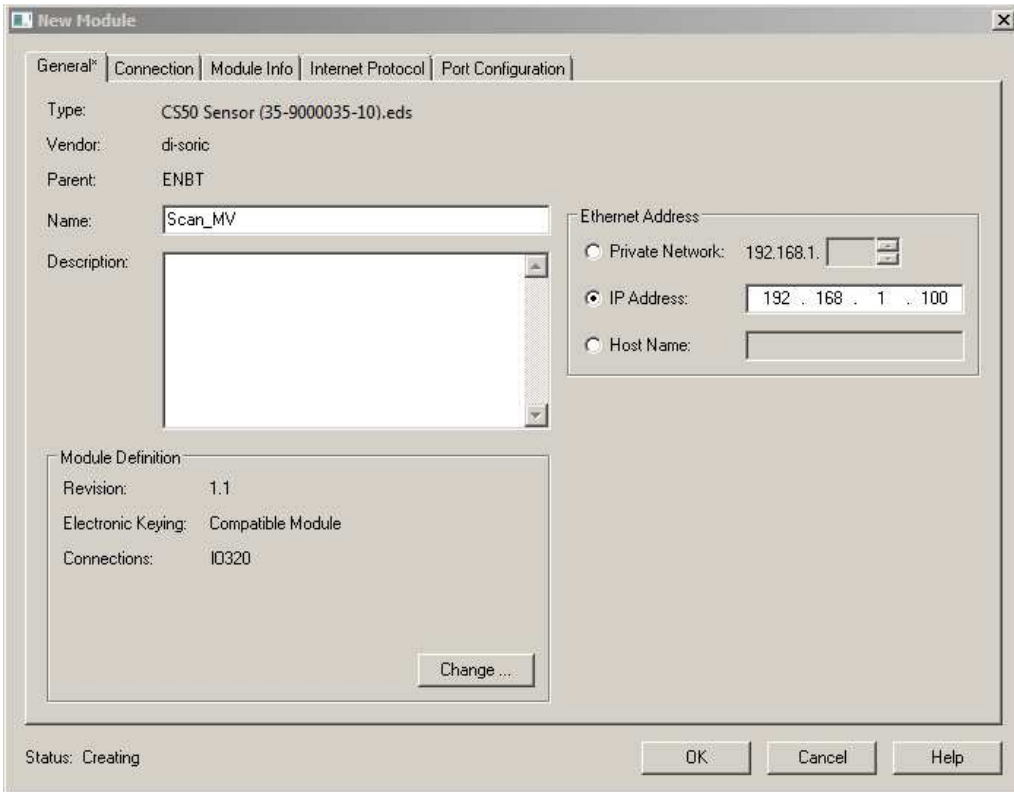

Click **OK**, verify the camera was added to the Ethernet network, then open the controller tags to verify that **:I** and **:O** tag sets were created.

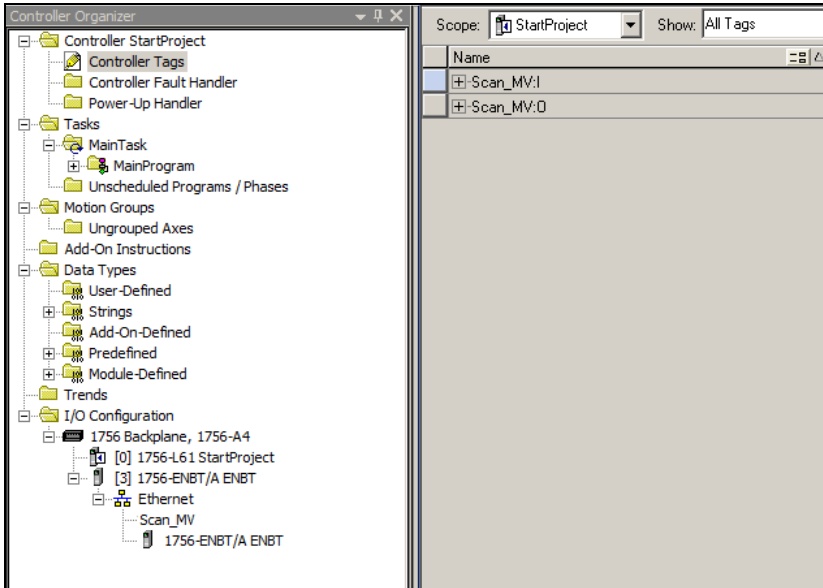

Open the **Main Routine**.

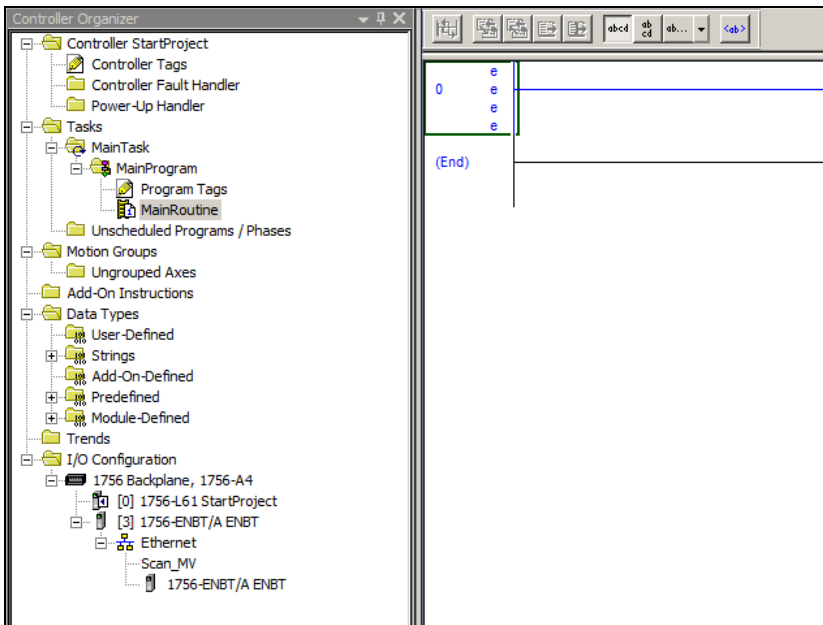

Right-click rung 0, and select **Import Rungs**.

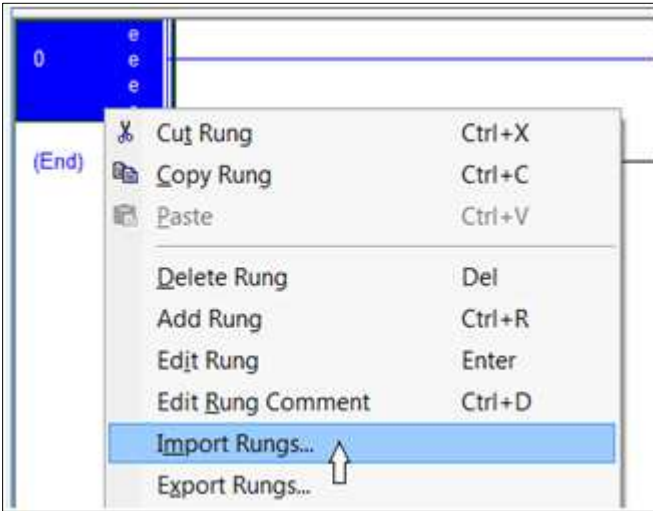

Navigate to the CS50 Sensor **32-000003-2.L5X** file and select **Import**. The default install directory is **C:\di-soric\Vscape\Tutorials and Samples\CS50\EIP Demo**.

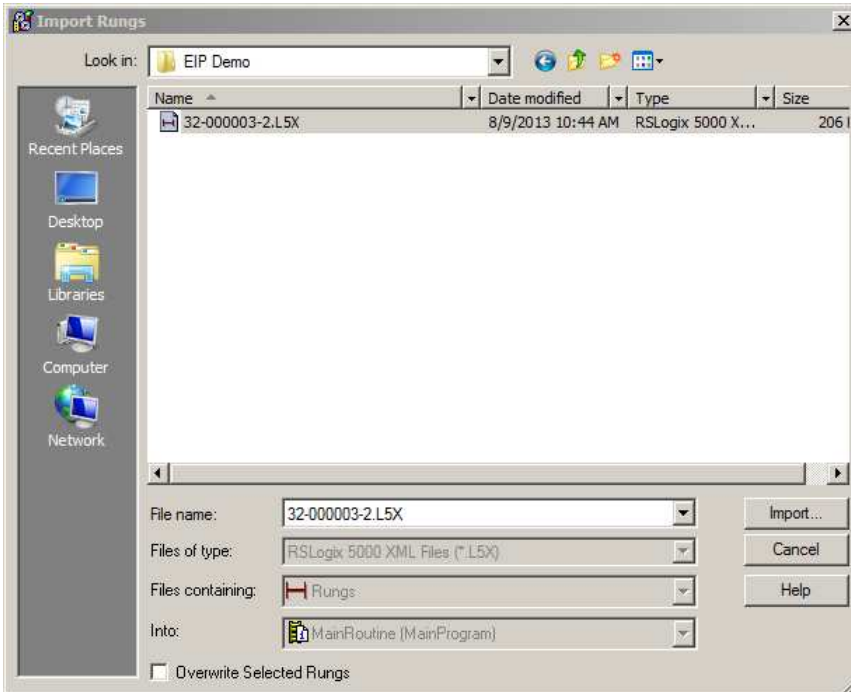

The **Import Configuration** dialog will be displayed.

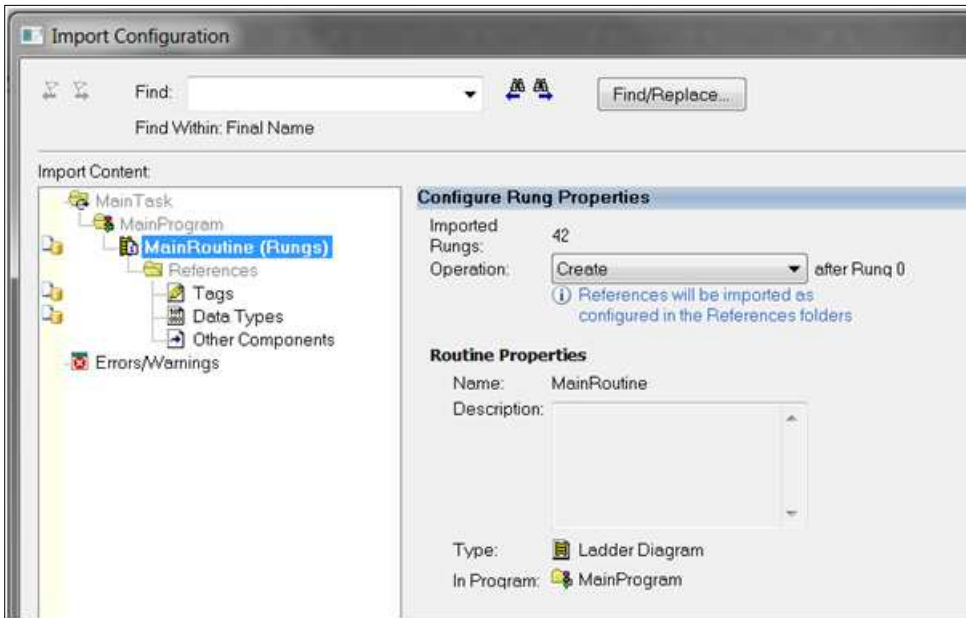

Select **Tags**.

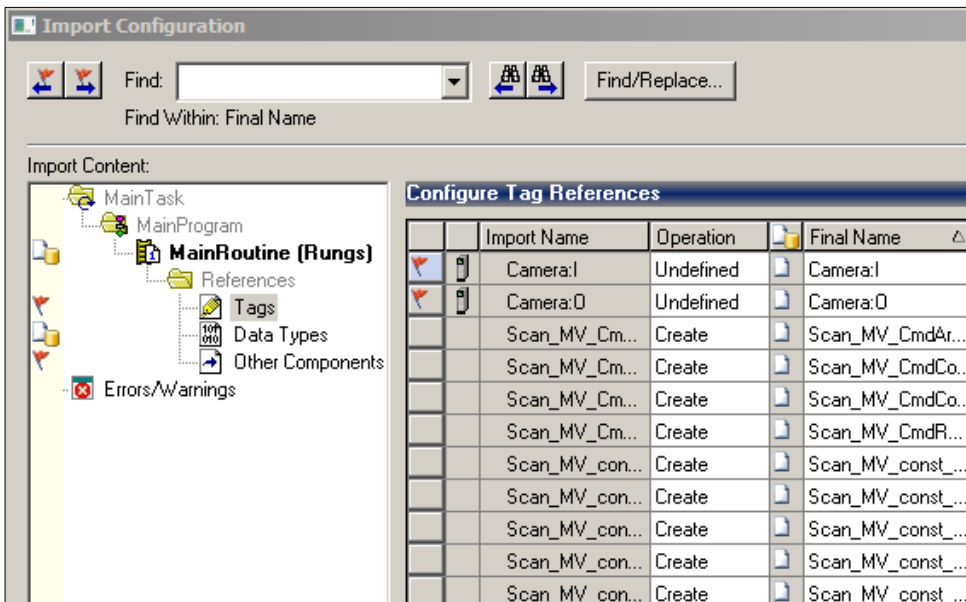

In the **Final Name** column, click **Camera:I**, then click the down arrow that appears on the right.

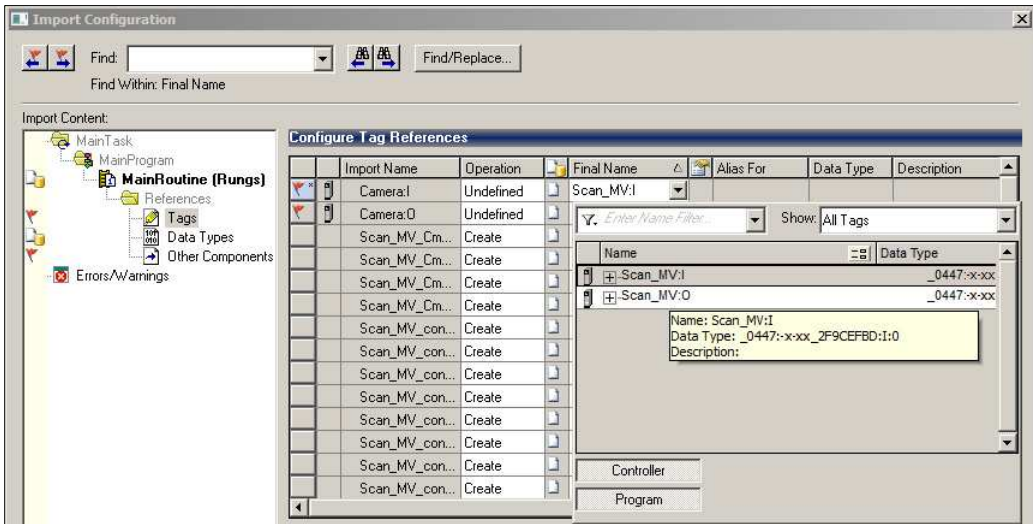

Double-click the camera name input tag assigned earlier.

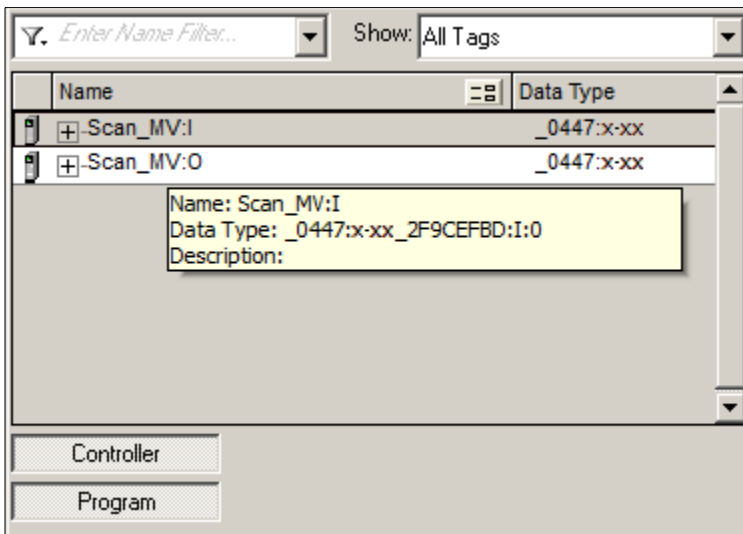

In the **Final Name** column, click **Camera:O**, then click the down arrow that appears on the right.

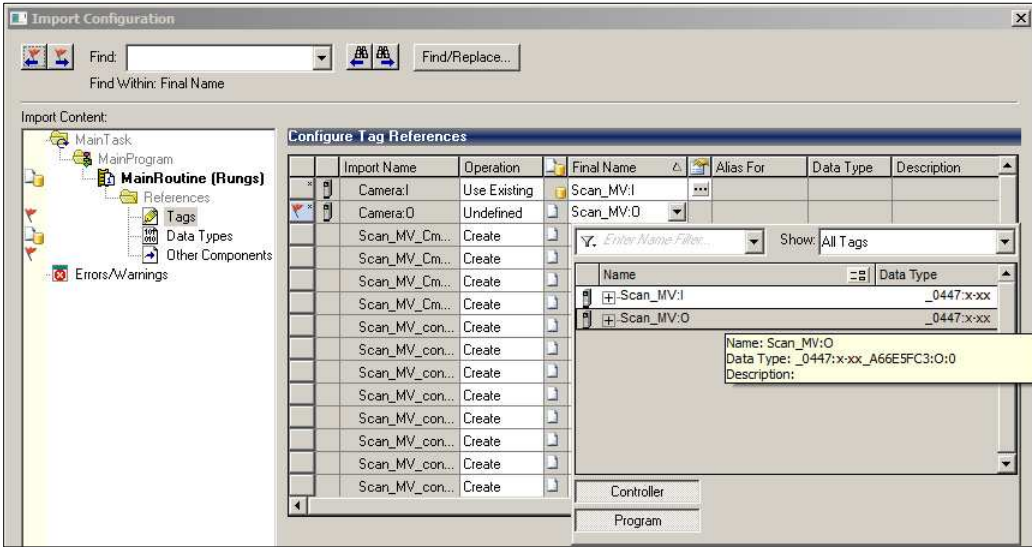

Double-click the camera name output tag assigned earlier.

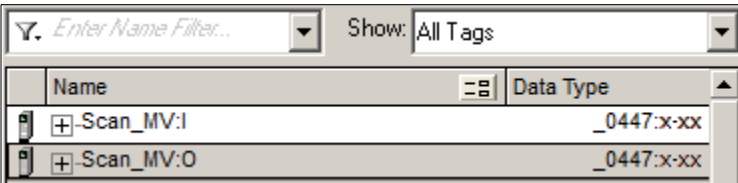

Click the **Other Components** icon in the tree view to select the **Component References**. Select the camera in the **Final Name** column. Click **OK** to complete the import.

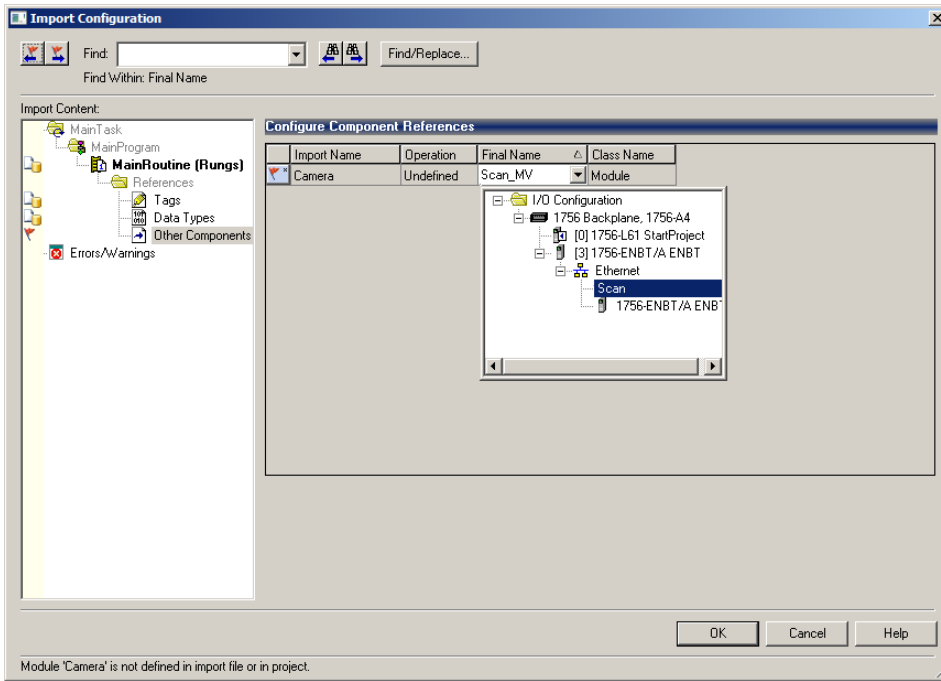

Click **OK** and the **Main Routine** and **User-Defined** tags will be populated.

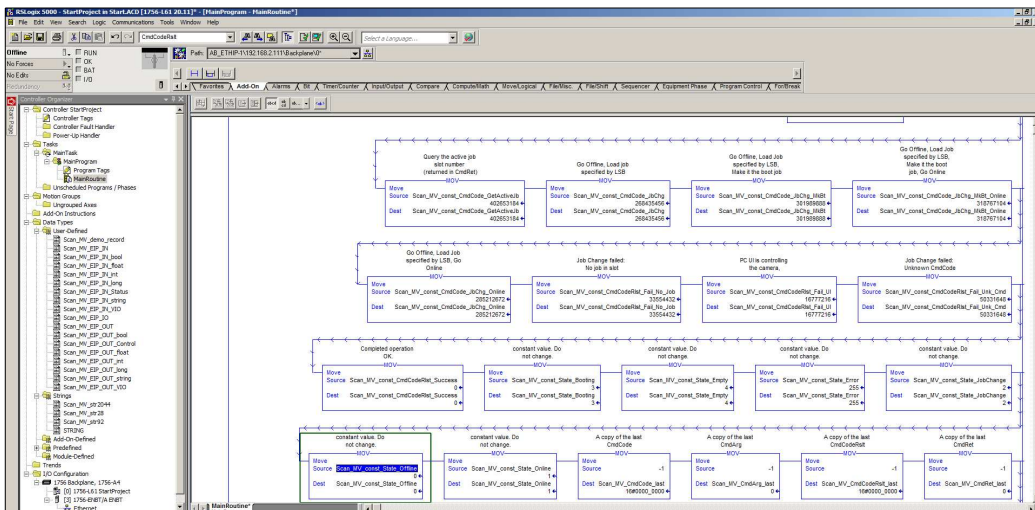

Delete any empty rungs (check rung 0).



Download the project to the PLC.

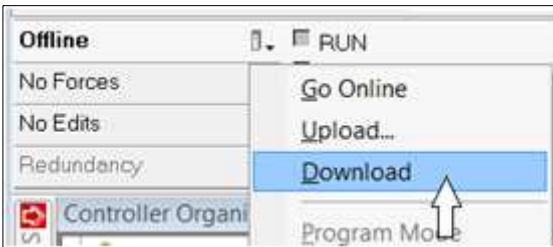

Note: Be sure the path to the PLC has been set in the project so that communications to the PLC can be established.

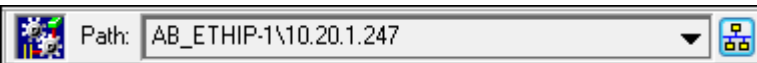

Put the PLC in **Run Mode**.

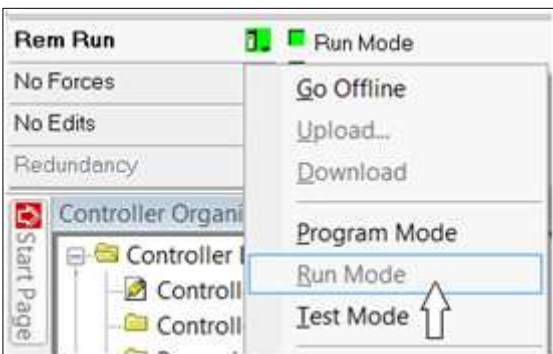

Open the **Program Tags** window and select **Monitor Tags**.

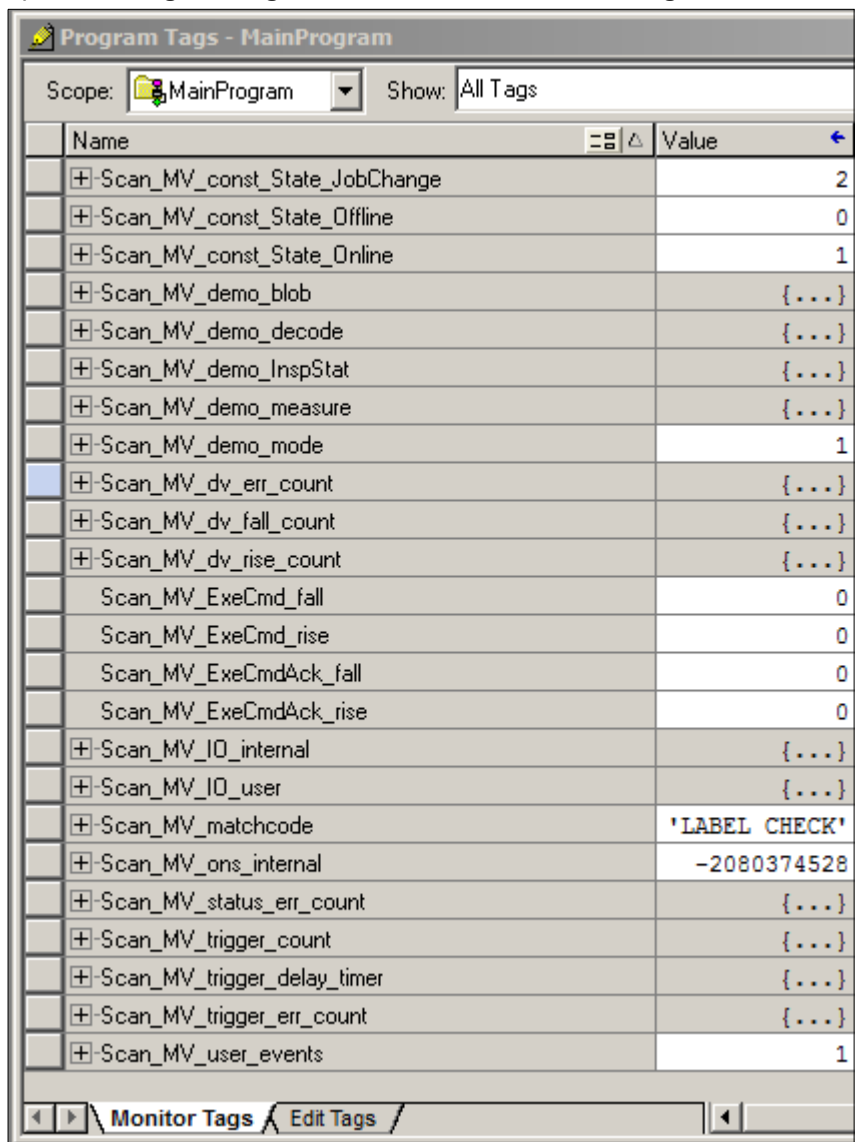

Expand **Scan_MV_IO_user** so that the **Echo** in the **.IN.Status** and **.OUT.Control** structures is visible.

Name	Value
Scan_MV_IO_user.IN.Status.reserved15	0
Scan_MV_IO_user.IN.Status.Echo	0
Scan_MV_IO_user.IN.Status.CmdCodeRslt	16#0000_0000
Scan_MV_IO_user.IN.Status.CmdRet	0
Scan_MV_IO_user.IN.Status.reserved96_103	0
Scan_MV_IO_user.IN.Status.reserved104_111	0
Scan_MV_IO_user.IN.Status.State	1
Scan_MV_IO_user.IN.Status.reserved120_127	0
Scan_MV_IO_user.IN.VID	{...}
Scan_MV_IO_user.IN.bool	{...}
Scan_MV_IO_user.IN.int	{...}
Scan_MV_IO_user.IN.long	{...}
Scan_MV_IO_user.IN.float	{...}
Scan_MV_IO_user.IN.string	{...}
Scan_MV_IO_user.OUT	{...}
Scan_MV_IO_user.OUT.Control	{...}
Scan_MV_IO_user.OUT.Control.GoOnline	0
Scan_MV_IO_user.OUT.Control.GoOffline	0
Scan_MV_IO_user.OUT.Control.reserved2	0
Scan_MV_IO_user.OUT.Control.reserved3	0
Scan_MV_IO_user.OUT.Control.ResetError	0
Scan_MV_IO_user.OUT.Control.ResetCount	0
Scan_MV_IO_user.OUT.Control.reserved6	0
Scan_MV_IO_user.OUT.Control.ExeCmd	0
Scan_MV_IO_user.OUT.Control.Trigger	0
Scan_MV_IO_user.OUT.Control.reserved9	0
Scan_MV_IO_user.OUT.Control.reserved10	0
Scan_MV_IO_user.OUT.Control.ResetDataValid	0
Scan_MV_IO_user.OUT.Control.reserved12	0
Scan_MV_IO_user.OUT.Control.reserved13	0
Scan_MV_IO_user.OUT.Control.reserved14	0
Scan_MV_IO_user.OUT.Control.reserved15	0
Scan_MV_IO_user.OUT.Control.Echo	0
Scan_MV_IO_user.OUT.Control.CmdCode	16#0000_0000
Scan_MV_IO_user.OUT.Control.CmdArg	0

Change **.OUT.Control.Echo** to non-zero.

— Scan_MV_IO_user.OUT.Control.reserved15	0
+ Scan_MV_IO_user.OUT.Control.Echo	4321
+ Scan_MV_IO_user.OUT.Control.CmdCode	16#0000_0000

Verify that **Scan_MV_IO_user.IO.IN.Status.Echo** is the same value as the **.OUT.Control.Echo**.

— Scan_MV_IO_user.IN.Status.reserved15	0
+ Scan_MV_IO_user.IN.Status.Echo	4321
+ Scan_MV_IO_user.IN.Status.CmdCodeRslt	16#0000_0000

This confirms that the PLC and camera have successful two-way communication.

The demo code expects a demo vision job to be loaded on the camera, which populates the following input tags (camera to PLC) with vision tool results:

- .IN.bool.bool1, bool2, and bool3
- .IN.long.long1
- .IN.float.float1
- .IN.string.string1

The demo code will operate the **Control** and **Status** signals of the camera regardless of the vision job that is loaded. For a more detailed overview of the demo code and vision job, see [Allen-Bradley PLC Setup via Generic Ethernet Module for EtherNet/IP Operation](#).

To send a trigger to the camera, scroll to **Scan_MV_IO_user.Control.Trigger**.

— Scan_MV_IO_user.OUT.Control.ExeCmd	0
— Scan_MV_IO_user.OUT.Control.Trigger	0
— Scan_MV_IO_user.OUT.Control.reserved9	0

Set the Trigger to **1**. This causes the demo code to trigger the camera, process the new inspection data, record the results in the **Scan_MV_demo_xxxx** tags, and clear the **DataValid** status signal.

The **Trigger** control changes to **0** when the camera is triggered. All processing is done when the counter **Scan_MV_dv_fall_count** increments, along with the pass/fail counters in the **Scan_MV_demo_xxxx** tags.

Name	Value
[-] Scan_MV_demo_blob	{...}
[+] Scan_MV_demo_blob.pass_count	{...}
[-] Scan_MV_demo_blob.fail_count	{...}
[+] Scan_MV_demo_blob.fail_count.PRE	0
[+] Scan_MV_demo_blob.fail_count.ACC	30
[-] Scan_MV_demo_blob.fail_count.CU	0
[-] Scan_MV_demo_blob.fail_count.CD	0
[-] Scan_MV_demo_blob.fail_count.DN	1
[-] Scan_MV_demo_blob.fail_count.OV	0
[-] Scan_MV_demo_blob.fail_count.UN	0
[-] Scan_MV_demo_blob.bool	0
[+] Scan_MV_demo_blob.long	6
[+] Scan_MV_demo_blob.long_max	6
[+] Scan_MV_demo_blob.long_min	4
[-] Scan_MV_demo_blob.float	0.0
[-] Scan_MV_demo_blob.float_min	0.0
[-] Scan_MV_demo_blob.float_max	0.0
[+] Scan_MV_demo_blob.string	''
[+] Scan_MV_demo_decode	{...}
[+] Scan_MV_demo_InspStat	{...}
[+] Scan_MV_demo_measure	{...}
[+] Scan_MV_demo_mode	1
[+] Scan_MV_dv_err_count	{...}
[-] Scan_MV_dv_fall_count	{...}
[+] Scan_MV_dv_fall_count.PRE	0
[+] Scan_MV_dv_fall_count.ACC	59
[-] Scan_MV_dv_fall_count.CU	0

Allen-Bradley PLC Setup via Generic Ethernet Module for EtherNet/IP Operation

This section describes how to use the Generic Ethernet Module to set up an Allen-Bradley PLC for EtherNet/IP operation.

Notes:

- The camera communications protocol must be enabled for EtherNet/IP before it can be used in this environment. Refer to **Chapter 1**, [Enabling Industrial Protocols](#), for information about enabling communications protocols for the CS50 Sensor, and information about switching CS50 Sensor communications protocols.
- CS50 Software jobs use di-soric Link functionality to accommodate EtherNet/IP communications between the camera and the PLC. For information about how to connect job parameters and outputs to di-soric Link tags, refer to the **di-soric Link** section of *CS50 Software Help*.

Integrating the Camera into a PLC Environment

This section assumes you are using an Allen Bradley PLC with Rockwell RSLogix 5000 v16 or newer. RSLogix v19 and v20 may look slightly different than the screen shots shown, but the integration process is similar.

Create the **I/O Configuration** for the base system, including the system's Ethernet interface.

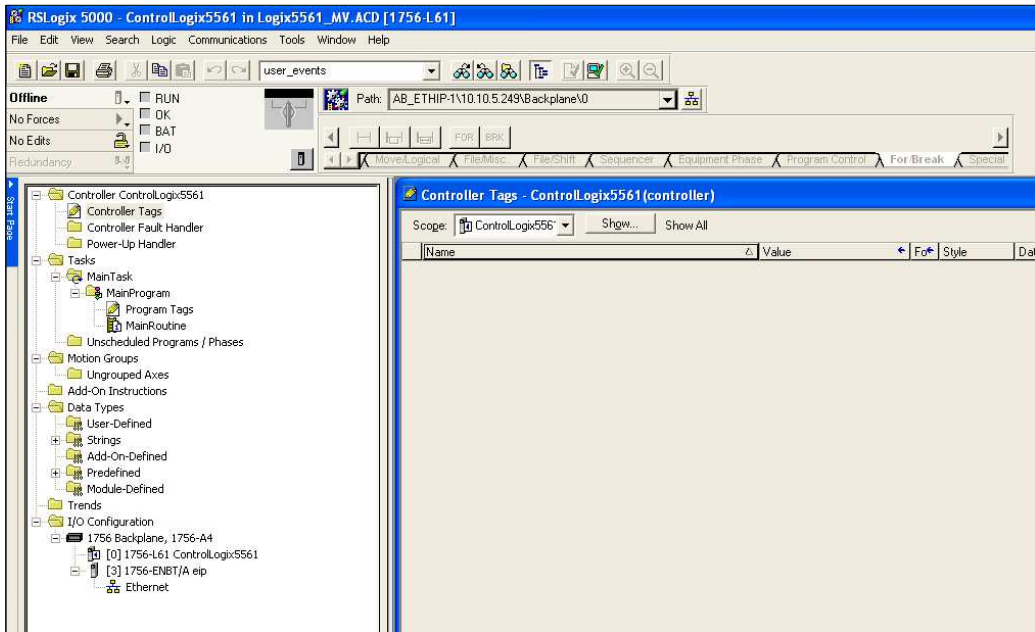

Add the camera by right-clicking the Ethernet interface and selecting **New Module**.

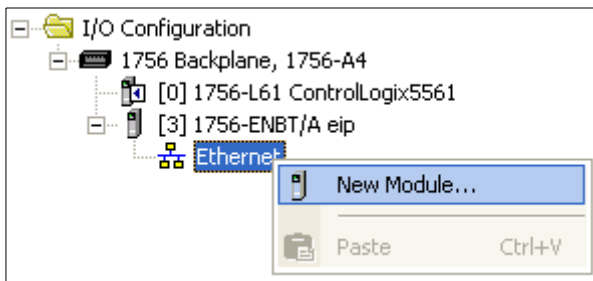

Select **ETHERNET-MODULE – Generic Ethernet Module**, and click **OK**.

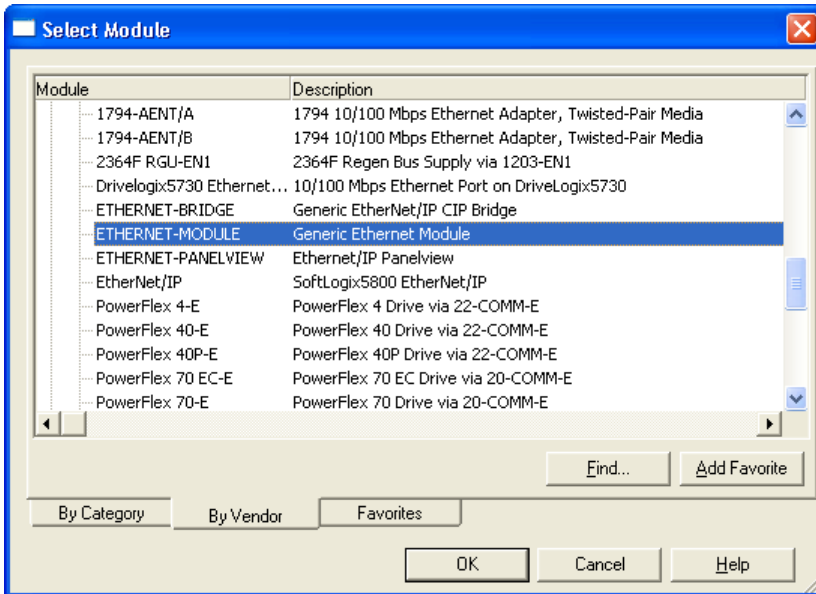

Configure the following fields:

Name: A useful name to remember for the camera. The example here is **Scan_MV**.

IP Address: The IP Address of the camera

Comm Format: “Data – DINT”

Input, Assembly Instance: 102

Input, Size: 80

Output, Assembly Instance: 114

Output, Size: 80

Configuration, Assembly Instance: 1

Configuration, Size: 0 (none)

Click **OK** when done.

Example:

New Module

Type: ETHERNET-MODULE Generic Ethernet Module
Vendor: Allen-Bradley
Parent: ENBT
Name: Scan_MV
Description:
Comm Format: Data - DINT
Address / Host Name:
 IP Address: . . .
 Host Name:
Connection Parameters:
Input: Assembly Instance: 102, Size: 80 (32-bit)
Output: Assembly Instance: 114, Size: 80 (32-bit)
Configuration: Assembly Instance: 1, Size: 0 (8-bit)
Status Input:
Status Output:
 Open Module Properties
OK Cancel Help

Configure the **Required Packet Interval (RPI)** and click **OK**.

10 ms is the minimum allowed by the camera. **20 ms** or higher is recommended.

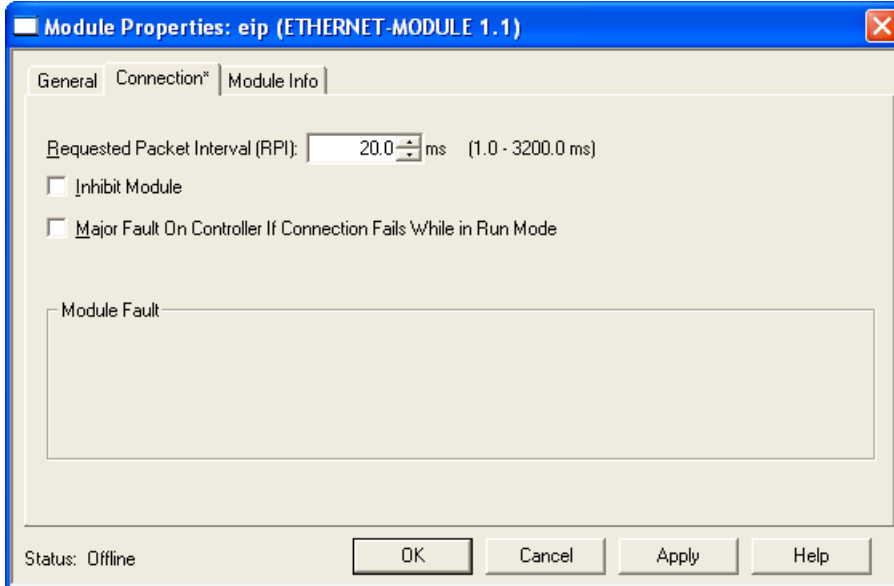

Open the **Main Routine**.

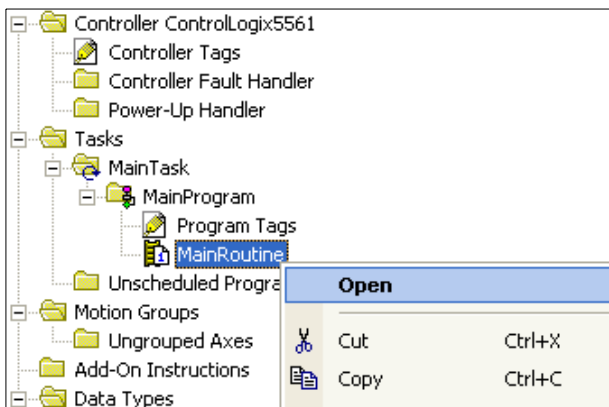

Right-click the top rung and select **Import Rung**.

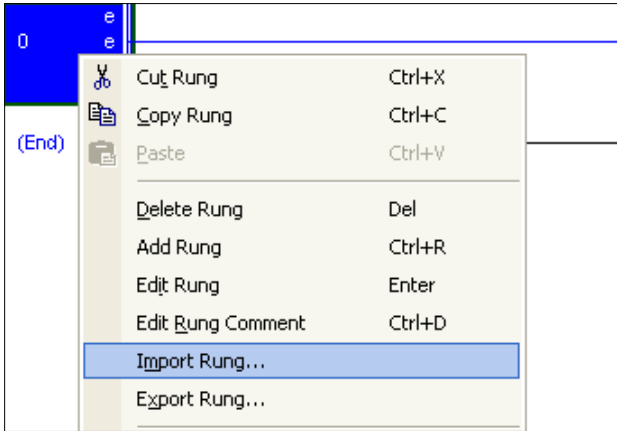

Navigate to the **32-000003-2.L5X** file and click **Import**.

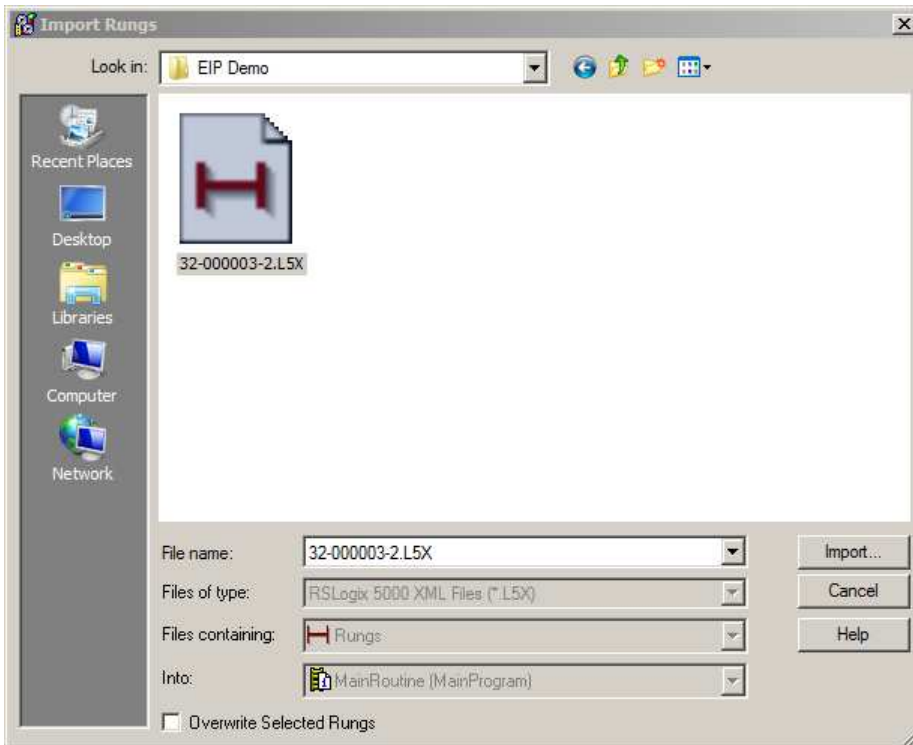

At the **Import Configuration** window, find the **Module Name** that was assigned to the **Generic Module**. Here the module name is **Camera**.

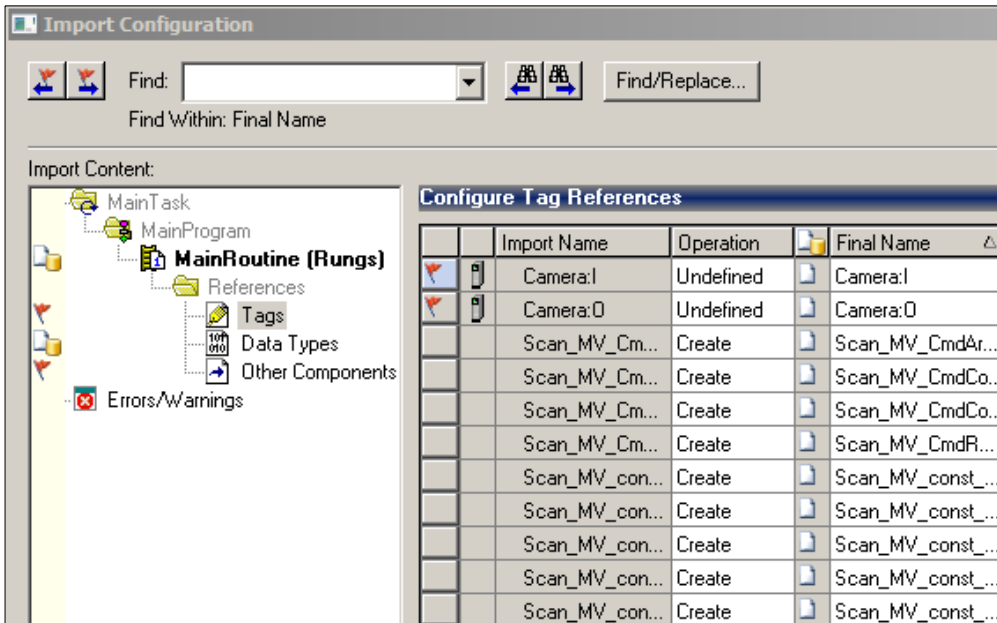

Click **Camera:I** and click the down arrow, then double-click the **Scan_MV:I** that appears below it.

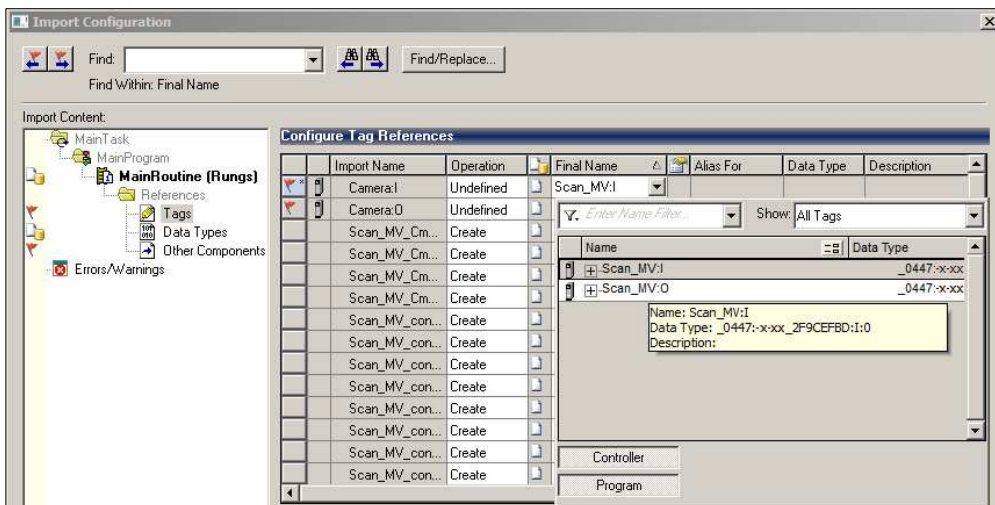

Click **Camera:O** and click the down-arrow, then double click the **Scan_MV:O** that appears below it.

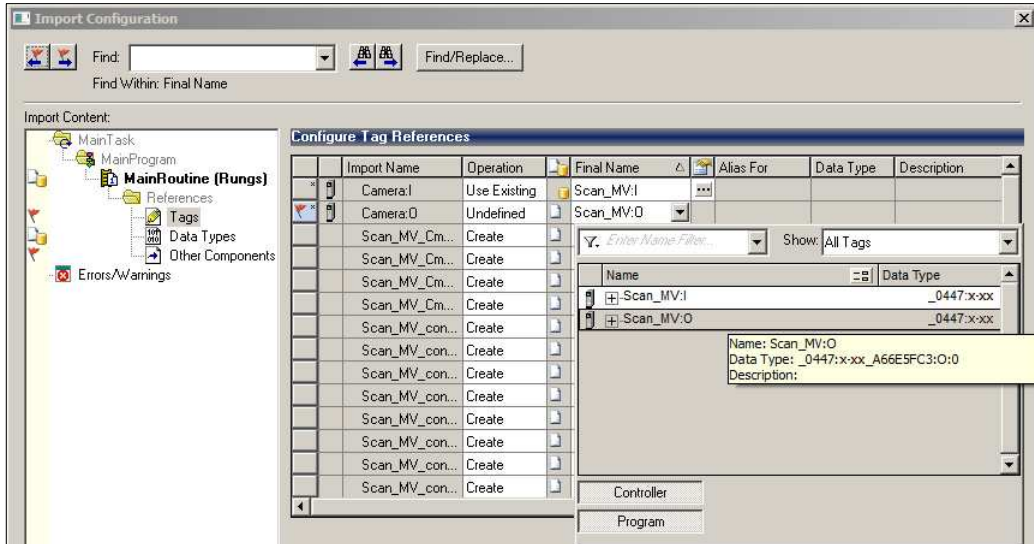

Click the **Other Components** icon in the tree view. Click **OK**.

Delete any empty rungs (rung **0** may be empty).

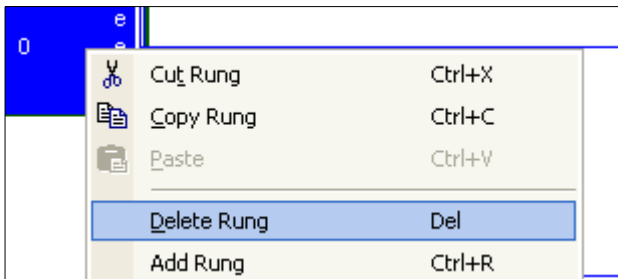

The tags and main program are now configured sufficiently to test communication with the camera.

Select the control button next to **Offline** and then select **Download**.

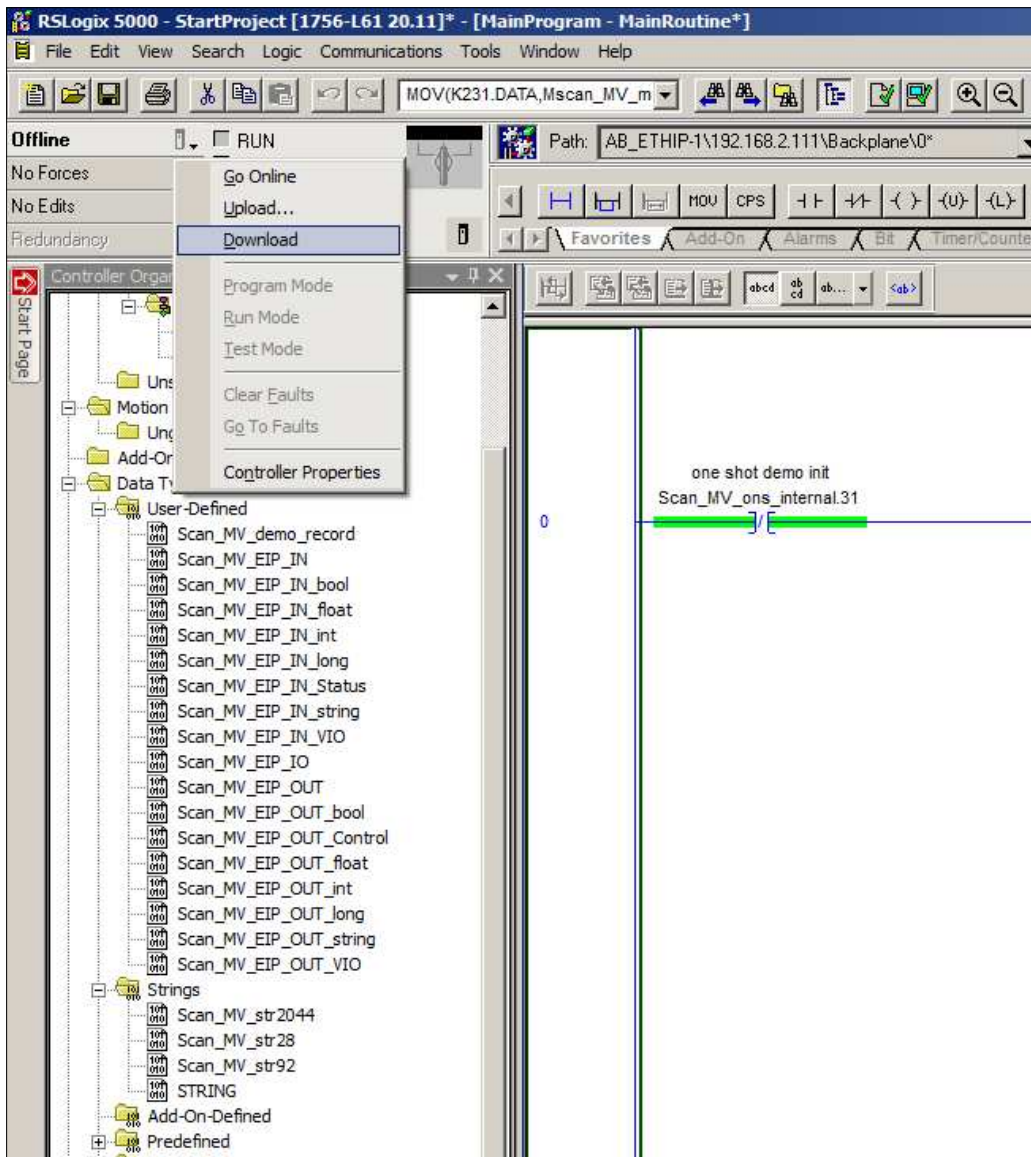

Note: Be sure the path to the PLC has been set in the project so that communications to the PLC can be established.

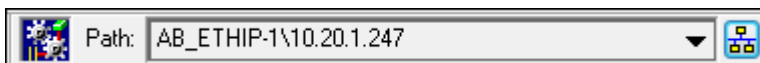

Once the program has downloaded, make sure the PLC is in **Run Mode**.

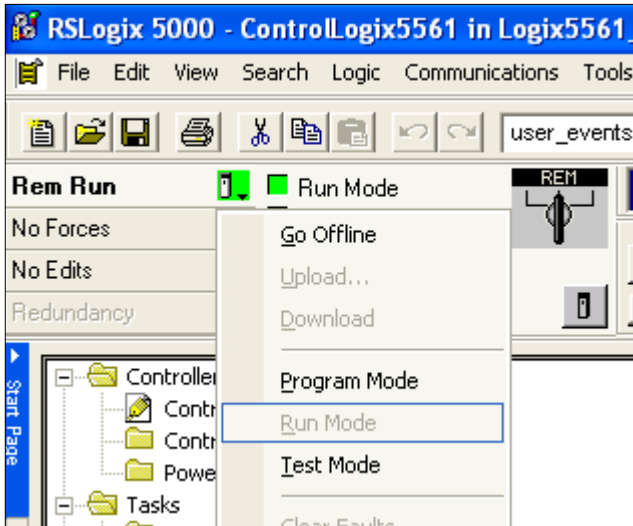

To open the **Program Tags**, double-click Program Tags, then select the **Monitor Tags** tab at the bottom of the tag window.

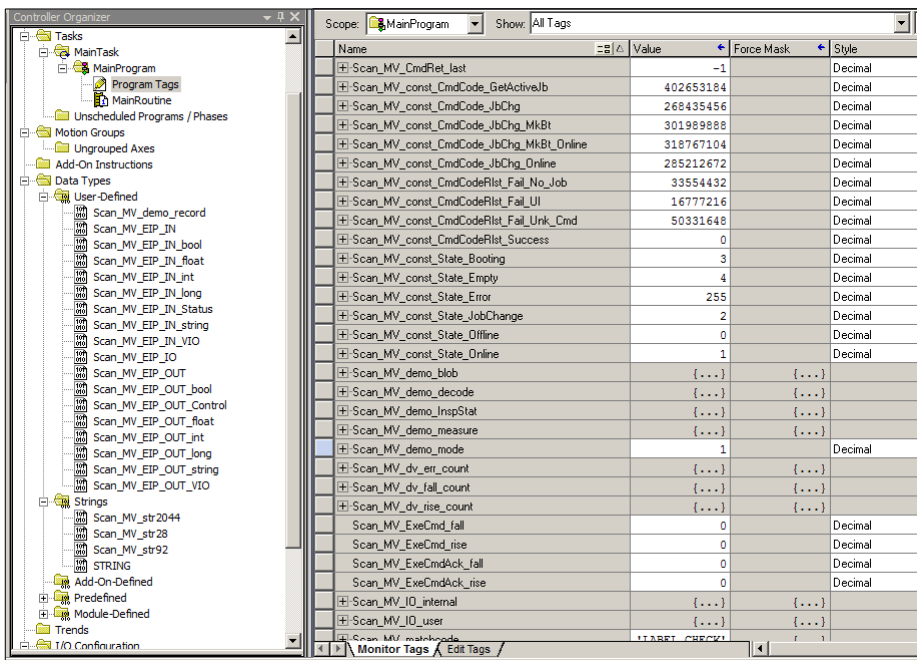

Expand **Scan_MV_IO_user** so that the **.IN.Status** and **.OUT.Control** structures are visible. Then scroll the window so **Scan_MV_IO_user.OUT.Control.Echo** is visible.

Name	Value
Scan_MV_IO_user.IN.Status.reserved15	0
Scan_MV_IO_user.IN.Status.Echo	0
Scan_MV_IO_user.IN.Status.CmdCodeRslt	16#0000_0000
Scan_MV_IO_user.IN.Status.CmdRet	0
Scan_MV_IO_user.IN.Status.reserved96_103	0
Scan_MV_IO_user.IN.Status.reserved104_111	0
Scan_MV_IO_user.IN.Status.State	1
Scan_MV_IO_user.IN.Status.reserved120_127	0
Scan_MV_IO_user.IN.VID	{...}
Scan_MV_IO_user.IN.bool	{...}
Scan_MV_IO_user.IN.int	{...}
Scan_MV_IO_user.IN.long	{...}
Scan_MV_IO_user.IN.float	{...}
Scan_MV_IO_user.IN.string	{...}
Scan_MV_IO_user.OUT	{...}
Scan_MV_IO_user.OUT.Control	{...}
Scan_MV_IO_user.OUT.Control.GoOnline	0
Scan_MV_IO_user.OUT.Control.GoOffline	0
Scan_MV_IO_user.OUT.Control.reserved2	0
Scan_MV_IO_user.OUT.Control.reserved3	0
Scan_MV_IO_user.OUT.Control.ResetError	0
Scan_MV_IO_user.OUT.Control.ResetCount	0
Scan_MV_IO_user.OUT.Control.reserved6	0
Scan_MV_IO_user.OUT.Control.ExeCmd	0
Scan_MV_IO_user.OUT.Control.Trigger	0
Scan_MV_IO_user.OUT.Control.reserved9	0
Scan_MV_IO_user.OUT.Control.reserved10	0
Scan_MV_IO_user.OUT.Control.ResetDataValid	0
Scan_MV_IO_user.OUT.Control.reserved12	0
Scan_MV_IO_user.OUT.Control.reserved13	0
Scan_MV_IO_user.OUT.Control.reserved14	0
Scan_MV_IO_user.OUT.Control.reserved15	0
Scan_MV_IO_user.OUT.Control.Echo	0
Scan_MV_IO_user.OUT.Control.CmdCode	16#0000_0000
Scan_MV_IO_user.OUT.Control.CmdArg	0

Change **.OUT.Control.Echo** to non-zero.

Name	Value
+ Scan_MV_IO_user.IN.Status.reserved104_111	0
+ Scan_MV_IO_user.IN.Status.State	1
+ Scan_MV_IO_user.IN.Status.reserved120_127	0
+ Scan_MV_IO_user.IN.VIO	{...}
+ Scan_MV_IO_user.IN.bool	{...}
+ Scan_MV_IO_user.IN.int	{...}
+ Scan_MV_IO_user.IN.long	{...}
+ Scan_MV_IO_user.IN.float	{...}
+ Scan_MV_IO_user.IN.string	{...}
- Scan_MV_IO_user.OUT	{...}
- Scan_MV_IO_user.OUT.Control	{...}
- Scan_MV_IO_user.OUT.Control.GoOnline	0
- Scan_MV_IO_user.OUT.Control.GoOffline	0
- Scan_MV_IO_user.OUT.Control.reserved2	0
- Scan_MV_IO_user.OUT.Control.reserved3	0
- Scan_MV_IO_user.OUT.Control.ResetError	0
- Scan_MV_IO_user.OUT.Control.ResetCount	0
- Scan_MV_IO_user.OUT.Control.reserved6	0
- Scan_MV_IO_user.OUT.Control.ExeCmd	0
- Scan_MV_IO_user.OUT.Control.Trigger	0
- Scan_MV_IO_user.OUT.Control.reserved9	0
- Scan_MV_IO_user.OUT.Control.reserved10	0
- Scan_MV_IO_user.OUT.Control.ResetDataValid	0
- Scan_MV_IO_user.OUT.Control.reserved12	0
- Scan_MV_IO_user.OUT.Control.reserved13	0
- Scan_MV_IO_user.OUT.Control.reserved14	0
- Scan_MV_IO_user.OUT.Control.reserved15	0
+ Scan_MV_IO_user.OUT.Control.Echo	1234
+ Scan_MV_IO_user.OUT.Control.CmdCode	16#0000_0000
+ Scan_MV_IO_user.OUT.Control.CmdArg	0
+ Scan_MV_IO_user.OUT.Control.reserved96_127	0

Monitor Tags / Edit Tags

Scroll the window so **Scan_MV_IO_user.IO.IN.Status.Echo** is visible, and verify that it is the same value as **.OUT.Control.Echo**.

Name	Value
Scan_MV_ExeCmdAck_rise	0
+ Scan_MV_IO_internal	{...}
- Scan_MV_IO_user	{...}
- Scan_MV_IO_user.IN	{...}
- Scan_MV_IO_user.IN.Status	{...}
- Scan_MV_IO_user.IN.Status.Online	1
- Scan_MV_IO_user.IN.Status.ExpBusy	0
- Scan_MV_IO_user.IN.Status.AcqBusy	0
- Scan_MV_IO_user.IN.Status.TriggerReady	1
- Scan_MV_IO_user.IN.Status.Error	0
- Scan_MV_IO_user.IN.Status.ResetCountAck	0
- Scan_MV_IO_user.IN.Status.reserved6	0
- Scan_MV_IO_user.IN.Status.ExeCmdAck	0
- Scan_MV_IO_user.IN.Status.TriggerAck	0
- Scan_MV_IO_user.IN.Status.InspBusy	0
- Scan_MV_IO_user.IN.Status.InspStat	0
- Scan_MV_IO_user.IN.Status.DataValid	0
- Scan_MV_IO_user.IN.Status.reserved12	0
- Scan_MV_IO_user.IN.Status.reserved13	0
- Scan_MV_IO_user.IN.Status.reserved14	0
- Scan_MV_IO_user.IN.Status.reserved15	0
+ Scan_MV_IO_user.IN.Status.Echo	1234
+ Scan_MV_IO_user.IN.Status.CmdCodeRslt	16#0000_0000
+ Scan_MV_IO_user.IN.Status.CmdRet	0
+ Scan_MV_IO_user.IN.Status.reserved96_103	0
+ Scan_MV_IO_user.IN.Status.reserved104_111	0
+ Scan_MV_IO_user.IN.Status.State	1
+ Scan_MV_IO_user.IN.Status.reserved120_127	0
+ Scan_MV_IO_user.IN.VIO	{...}
+ Scan_MV_IO_user.IN.bool	{...}
+ Scan_MV_IO_user.IN.int	{...}

Monitor Tags / Edit Tags

This confirms that the PLC and camera have successful two-way communication.

To send a trigger to the camera, scroll to **Scan_MV_IO_user.Control.Trigger**.

Name	Value
Scan_MV_IO_user.IN.int	{...}
Scan_MV_IO_user.IN.long	{...}
Scan_MV_IO_user.IN.float	{...}
Scan_MV_IO_user.IN.string	{...}
Scan_MV_IO_user.OUT	{...}
Scan_MV_IO_user.OUT.Control	{...}
Scan_MV_IO_user.OUT.Control.GoOnline	0
Scan_MV_IO_user.OUT.Control.GoOffline	0
Scan_MV_IO_user.OUT.Control.reserved2	0
Scan_MV_IO_user.OUT.Control.reserved3	0
Scan_MV_IO_user.OUT.Control.ResetError	0
Scan_MV_IO_user.OUT.Control.ResetCount	0
Scan_MV_IO_user.OUT.Control.reserved6	0
Scan_MV_IO_user.OUT.Control.ExeCmd	0
Scan_MV_IO_user.OUT.Control.Trigger	0
Scan_MV_IO_user.OUT.Control.reserved9	0

Set the **Trigger** to **1**. This causes the demo code to trigger the camera, process the new inspection data, record the results in the **Scan_MV_demo_xxxx** tags, and clear the **DataValid** status signal. The **Trigger** control changes to **0** when the camera is triggered. The **Scan_MV_dv_fall_count** and **pass/fail** counters in the **Scan_MV_demo_xxxx** tags increment when all processing is done. For example:

Name	Value
- Scan_MV_demo_blob	{...}
- Scan_MV_demo_blob.pass_count	{...}
+ Scan_MV_demo_blob.pass_count.PRE	0
+ Scan_MV_demo_blob.pass_count.ACC	1
- Scan_MV_demo_blob.pass_count.CU	0
- Scan_MV_demo_blob.pass_count.CD	0
- Scan_MV_demo_blob.pass_count.DN	1
- Scan_MV_demo_blob.pass_count.OV	0
- Scan_MV_demo_blob.pass_count.UN	0
+ Scan_MV_demo_blob.fail_count	{...}
- Scan_MV_demo_blob.bool	0
+ Scan_MV_demo_blob.long	6
+ Scan_MV_demo_blob.long_max	6
+ Scan_MV_demo_blob.long_min	4
- Scan_MV_demo_blob.float	0.0
- Scan_MV_demo_blob.float_min	0.0
- Scan_MV_demo_blob.float_max	0.0
+ Scan_MV_demo_blob.string	''
+ Scan_MV_demo_decode	{...}
+ Scan_MV_demoInspStat	{...}
+ Scan_MV_demo_measure	{...}
+ Scan_MV_demo_mode	1
+ Scan_MV_dv_err_count	{...}
- Scan_MV_dv_fall_count	{...}
+ Scan_MV_dv_fall_count.PRE	0
+ Scan_MV_dv_fall_count.ACC	1
- Scan_MV_dv_fall_count.CU	0
- Scan_MV_dv_fall_count.CD	0
- Scan_MV_dv_fall_count.DN	1
- Scan_MV_dv_fall_count.OV	0
- Scan_MV_dv_fall_count.UN	0
+ Scan_MV_dv_rise_count	{...}

Parameterize the Camera

Open the **Scan_MV_IO_user.OUT.long**, **float**, and **string** tags and verify that they are configured as shown below.

Name	Value	Style	Data Type
[-] Scan_MV_IO_user	{ ... }	[Scan_...
[+] Scan_MV_IO_user.IN	{ ... }	[Scan_...
[-] Scan_MV_IO_user.OUT	{ ... }	[Scan_...
[+] Scan_MV_IO_user.OUT.Control	{ ... }	[Scan_...
[+] Scan_MV_IO_user.OUT.VID	{ ... }	[Scan_...
[+] Scan_MV_IO_user.OUT.bool	{ ... }	[Scan_...
[+] Scan_MV_IO_user.OUT.int	{ ... }	[Scan_...
[-] Scan_MV_IO_user.OUT.long	{ ... }	[Scan_...
[+] Scan_MV_IO_user.OUT.long.long101	4	Decimal	DINT
[+] Scan_MV_IO_user.OUT.long.long102	4	Decimal	DINT
[+] Scan_MV_IO_user.OUT.long.long103	0	Decimal	DINT
[+] Scan_MV_IO_user.OUT.long.long104	0	Decimal	DINT
[+] Scan_MV_IO_user.OUT.long.long105	0	Decimal	DINT
[+] Scan_MV_IO_user.OUT.long.long106	0	Decimal	DINT
[+] Scan_MV_IO_user.OUT.long.long107	0	Decimal	DINT
[+] Scan_MV_IO_user.OUT.long.long108	0	Decimal	DINT
[+] Scan_MV_IO_user.OUT.long.long109	0	Decimal	DINT
[+] Scan_MV_IO_user.OUT.long.long110	0	Decimal	DINT
[-] Scan_MV_IO_user.OUT.float	{ ... }	[Scan_...
[-] Scan_MV_IO_user.OUT.float.float101	100.0	Float	REAL
[-] Scan_MV_IO_user.OUT.float.float102	200.0	Float	REAL
[-] Scan_MV_IO_user.OUT.float.float103	0.0	Float	REAL
[-] Scan_MV_IO_user.OUT.float.float104	0.0	Float	REAL
[-] Scan_MV_IO_user.OUT.float.float105	0.0	Float	REAL
[-] Scan_MV_IO_user.OUT.float.float106	0.0	Float	REAL
[-] Scan_MV_IO_user.OUT.float.float107	0.0	Float	REAL
[-] Scan_MV_IO_user.OUT.float.float108	0.0	Float	REAL
[-] Scan_MV_IO_user.OUT.float.float109	0.0	Float	REAL
[-] Scan_MV_IO_user.OUT.float.float110	0.0	Float	REAL
[-] Scan_MV_IO_user.OUT.string	{ ... }	[Scan_...
[+] Scan_MV_IO_user.OUT.string.string101	'LABEL CHECK'	[Scan_...
[+] Scan_MV_IO_user.OUT.string.string102	''	[Scan_...
[+] Scan_MV_IO_user.OUT.string.string103	''	[Scan_...
[+] Scan_MV_IO_user.OUT.string.string104	''	[Scan_...
[+] Scan_MV_matchcode	'LABEL CHECK'	[Scan_...
[+] Scan_MV_ons_internal	-2080374528	Decimal	DINT
[+] Scan_MV_status_err_count	{ ... }	[COUN...

This configures the **Measure (float101 and float102)**, **Decode (string101)** and **Count Blob (long101 and long102)** tools in the same way they were configured in CS50 Software during Try Out.

Note the **Description** column. It offers a hint for what each linked tag does in the vision job.

Trigger the Camera

To send a trigger to the camera, scroll to **Scan_MV_IO_user.Control.Trigger**.

Name	Value
[-] Scan_MV_IO_user	{...}
+ Scan_MV_IO_user.IN	{...}
[-] Scan_MV_IO_user.OUT	{...}
[-] Scan_MV_IO_user.OUT.Control	{...}
- Scan_MV_IO_user.OUT.Control.GoOnline	0
- Scan_MV_IO_user.OUT.Control.GoOffline	0
- Scan_MV_IO_user.OUT.Control.reserved2	0
- Scan_MV_IO_user.OUT.Control.reserved3	0
- Scan_MV_IO_user.OUT.Control.ResetError	0
- Scan_MV_IO_user.OUT.Control.ResetCount	0
- Scan_MV_IO_user.OUT.Control.reserved6	0
- Scan_MV_IO_user.OUT.Control.ExeCmd	0
- Scan_MV_IO_user.OUT.Control.Trigger	0
- Scan_MV_IO_user.OUT.Control.reserved9	0
- Scan_MV_IO_user.OUT.Control.reserved10	0
- Scan_MV_IO_user.OUT.Control.ResetDataValid	0
- Scan_MV_IO_user.OUT.Control.reserved12	0

Set the **Trigger** to **1**. When the Trigger returns to a value of **0**, the camera may be re-triggered.

If you connect to the camera with CS50 Software, it will display a new inspection result each time the camera is triggered. Recall that the vision job was created with predefined images to produce predictable **Passed** and **Failed** results. The camera's illumination lights will not flash when triggered.

The inspection results can be seen in the PLCs's **IN** tags, as well as in CS50 Software. Open the RSLogix tag window so **Scan_MV_IO_user.IN.Status** and **bool** are visible.

This example shows a **Passed** inspection, where the following tags are all 1:

- IN.Status.InspStat
- IN.bool.bool1 (Measure status)
- IN.bool.bool2 (decode+matchcode status)
- IN.bool.bool3 (count blob status)

Name	Value	Style	Data Type	Description
[-] Scan_MV_IO_user	{...}	[Scan_...	user's device tags when M
[-] Scan_MV_IO_user.IN	{...}	[Scan_...	user's device tags when M
[-] Scan_MV_IO_user.IN.Status	{...}	[Scan_...	user's device tags when M
[-] Scan_MV_IO_user.IN.Status.Online	1	Decimal	BOOL	user's device tags when M
[-] Scan_MV_IO_user.IN.Status.ExpBusy	0	Decimal	BOOL	user's device tags when M
[-] Scan_MV_IO_user.IN.Status.AcqBusy	0	Decimal	BOOL	user's device tags when M
[-] Scan_MV_IO_user.IN.Status.TriggerReady	1	Decimal	BOOL	user's device tags when M
[-] Scan_MV_IO_user.IN.Status.Error	0	Decimal	BOOL	user's device tags when M
[-] Scan_MV_IO_user.IN.Status.ResetCountAck	0	Decimal	BOOL	user's device tags when M
[-] Scan_MV_IO_user.IN.Status.reserved6	0	Decimal	BOOL	user's device tags when M
[-] Scan_MV_IO_user.IN.Status.ExeCmdAck	0	Decimal	BOOL	user's device tags when M
[-] Scan_MV_IO_user.IN.Status.TriggerAck	0	Decimal	BOOL	user's device tags when M
[-] Scan_MV_IO_user.IN.Status.InspBusy	0	Decimal	BOOL	user's device tags when M
[-] Scan_MV_IO_user.IN.Status.InspStat	1	Decimal	BOOL	user's device tags when M
[-] Scan_MV_IO_user.IN.Status.DataValid	0	Decimal	BOOL	user's device tags when M
[-] Scan_MV_IO_user.IN.Status.reserved12	0	Decimal	BOOL	user's device tags when M
[-] Scan_MV_IO_user.IN.Status.reserved13	0	Decimal	BOOL	user's device tags when M
[-] Scan_MV_IO_user.IN.Status.reserved14	0	Decimal	BOOL	user's device tags when M
[-] Scan_MV_IO_user.IN.Status.reserved15	0	Decimal	BOOL	user's device tags when M
[+] Scan_MV_IO_user.IN.Status.Echo	0	Decimal	INT	user's device tags when M
[+] Scan_MV_IO_user.IN.Status.CmdCodeRslt	16#0000_0000	Hex	DINT	user's device tags when M
[+] Scan_MV_IO_user.IN.Status.CmdRet	0	Decimal	DINT	user's device tags when M
[+] Scan_MV_IO_user.IN.Status.reserved96_103	0	Decimal	SINT	user's device tags when M
[+] Scan_MV_IO_user.IN.Status.reserved104_111	0	Decimal	SINT	user's device tags when M
[+] Scan_MV_IO_user.IN.Status.State	1	Decimal	SINT	user's device tags when M
[+] Scan_MV_IO_user.IN.Status.reserved120_127	0	Decimal	SINT	user's device tags when M
[+] Scan_MV_IO_user.IN.VIO	{...}	[Scan_...	user's device tags when M
[-] Scan_MV_IO_user.IN.bool	{...}	[Scan_...	user's device tags when M
[-] Scan_MV_IO_user.IN.bool.bool1	1	Decimal	BOOL	measure status
[-] Scan_MV_IO_user.IN.bool.bool2	1	Decimal	BOOL	decode+matchcode status
[-] Scan_MV_IO_user.IN.bool.bool3	1	Decimal	BOOL	blob count status

If you scroll down to the **IN.long**, **float**, and **string** values, you will see the literal results of the vision tools.

Name	Value	Style	Data Type	Description
+ Scan_MV_IO_user.IN.VID	{...}		Scan_...	user's device tag
+ Scan_MV_IO_user.IN.bool	{...}		Scan_...	user's device tag
+ Scan_MV_IO_user.IN.int	{...}		Scan_...	user's device tag
- Scan_MV_IO_user.IN.long	{...}		Scan_...	user's device tag
+ Scan_MV_IO_user.IN.long.long1	4	Decimal	DINT	Blob count
+ Scan_MV_IO_user.IN.long.long2	0	Decimal	DINT	user's device tag
+ Scan_MV_IO_user.IN.long.long3	0	Decimal	DINT	user's device tag
+ Scan_MV_IO_user.IN.long.long4	0	Decimal	DINT	user's device tag
+ Scan_MV_IO_user.IN.long.long5	0	Decimal	DINT	user's device tag
+ Scan_MV_IO_user.IN.long.long6	0	Decimal	DINT	user's device tag
+ Scan_MV_IO_user.IN.long.long7	0	Decimal	DINT	user's device tag
+ Scan_MV_IO_user.IN.long.long8	0	Decimal	DINT	user's device tag
+ Scan_MV_IO_user.IN.long.long9	0	Decimal	DINT	user's device tag
+ Scan_MV_IO_user.IN.long.long10	0	Decimal	DINT	user's device tag
- Scan_MV_IO_user.IN.float	{...}		Scan_...	user's device tag
- Scan_MV_IO_user.IN.float.float1	173.0306	Float	REAL	Measure value
- Scan_MV_IO_user.IN.float.float2	0.0	Float	REAL	user's device tag
- Scan_MV_IO_user.IN.float.float3	0.0	Float	REAL	user's device tag
- Scan_MV_IO_user.IN.float.float4	0.0	Float	REAL	user's device tag
- Scan_MV_IO_user.IN.float.float5	0.0	Float	REAL	user's device tag
- Scan_MV_IO_user.IN.float.float6	0.0	Float	REAL	user's device tag
- Scan_MV_IO_user.IN.float.float7	0.0	Float	REAL	user's device tag
- Scan_MV_IO_user.IN.float.float8	0.0	Float	REAL	user's device tag
- Scan_MV_IO_user.IN.float.float9	0.0	Float	REAL	user's device tag
- Scan_MV_IO_user.IN.float.float10	0.0	Float	REAL	user's device tag
- Scan_MV_IO_user.IN.string	{...}		Scan_...	user's device tag
+ Scan_MV_IO_user.IN.string.string1	'LABEL CHECK'		Scan_...	Decode text

This is equivalent to the CS50 Software inspection result.

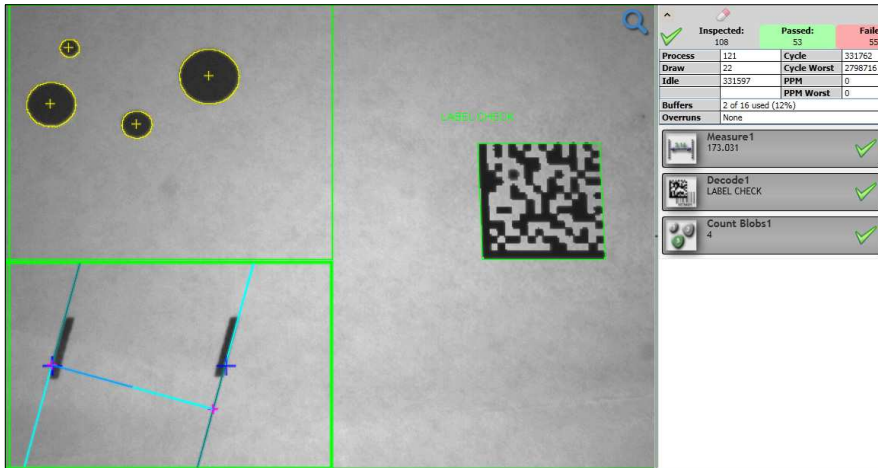

This example shows a **Failed** inspection, where every tool reports a fail.

Name	Value	Style	Data Type	Description
[-] Scan_MV_IO_user.IN	{ ... }	[Scan...	user's device tags
[-] Scan_MV_IO_user.IN.Status	{ ... }	[Scan...	user's device tags
[-] Scan_MV_IO_user.IN.Status.Offline	1	Decimal	BOOL	user's device tags
[-] Scan_MV_IO_user.IN.Status.ExpBusy	0	Decimal	BOOL	user's device tags
[-] Scan_MV_IO_user.IN.Status.AcqBusy	0	Decimal	BOOL	user's device tags
[-] Scan_MV_IO_user.IN.Status.TriggerReady	1	Decimal	BOOL	user's device tags
[-] Scan_MV_IO_user.IN.Status.Error	0	Decimal	BOOL	user's device tags
[-] Scan_MV_IO_user.IN.Status.ResetCountAck	0	Decimal	BOOL	user's device tags
[-] Scan_MV_IO_user.IN.Status.reserved6	0	Decimal	BOOL	user's device tags
[-] Scan_MV_IO_user.IN.Status.ExeCmdAck	0	Decimal	BOOL	user's device tags
[-] Scan_MV_IO_user.IN.Status.TriggerAck	0	Decimal	BOOL	user's device tags
[-] Scan_MV_IO_user.IN.Status.InspBusy	0	Decimal	BOOL	user's device tags
[-] Scan_MV_IO_user.IN.Status.InspStat	0	Decimal	BOOL	user's device tags
[-] Scan_MV_IO_user.IN.Status.DataValid	0	Decimal	BOOL	user's device tags
[-] Scan_MV_IO_user.IN.Status.reserved12	0	Decimal	BOOL	user's device tags
[-] Scan_MV_IO_user.IN.Status.reserved13	0	Decimal	BOOL	user's device tags
[-] Scan_MV_IO_user.IN.Status.reserved14	0	Decimal	BOOL	user's device tags
[-] Scan_MV_IO_user.IN.Status.reserved15	0	Decimal	BOOL	user's device tags
[+] Scan_MV_IO_user.IN.Status.Echo	0	Decimal	INT	user's device tags
[+] Scan_MV_IO_user.IN.Status.CmdCodeRst	16#0000_0000	Hex	DINT	user's device tags
[+] Scan_MV_IO_user.IN.Status.CmdRet	0	Decimal	DINT	user's device tags
[+] Scan_MV_IO_user.IN.Status.reserved96_103	0	Decimal	SINT	user's device tags
[+] Scan_MV_IO_user.IN.Status.reserved104_111	0	Decimal	SINT	user's device tags
[+] Scan_MV_IO_user.IN.Status.State	1	Decimal	SINT	user's device tags
[+] Scan_MV_IO_user.IN.Status.reserved120_127	0	Decimal	SINT	user's device tags
[+] Scan_MV_IO_user.IN.VID	{ ... }	[Scan...	user's device tags
[-] Scan_MV_IO_user.IN.bool	{ ... }	[Scan...	user's device tags
[-] Scan_MV_IO_user.IN.bool.blob1	0	Decimal	BOOL	measure status
[-] Scan_MV_IO_user.IN.bool.blob2	0	Decimal	BOOL	decode+matchcod
[-] Scan_MV_IO_user.IN.bool.blob3	0	Decimal	BOOL	blob count status

This is the Failed inspection's literal data.

Name	Value	Style	Data Type	Description
[-] Scan_MV_ID_user.IN.long	{ ... }	[Scan...	user's device tags
[-] Scan_MV_ID_user.IN.long.long1	6	Decimal	DINT	Blob count
[-] Scan_MV_ID_user.IN.long.long2	0	Decimal	DINT	user's device tags
[-] Scan_MV_ID_user.IN.long.long3	0	Decimal	DINT	user's device tags
[-] Scan_MV_ID_user.IN.long.long4	0	Decimal	DINT	user's device tags
[-] Scan_MV_ID_user.IN.long.long5	0	Decimal	DINT	user's device tags
[-] Scan_MV_ID_user.IN.long.long6	0	Decimal	DINT	user's device tags
[-] Scan_MV_ID_user.IN.long.long7	0	Decimal	DINT	user's device tags
[-] Scan_MV_ID_user.IN.long.long8	0	Decimal	DINT	user's device tags
[-] Scan_MV_ID_user.IN.long.long9	0	Decimal	DINT	user's device tags
[-] Scan_MV_ID_user.IN.long.long10	0	Decimal	DINT	user's device tags
[-] Scan_MV_ID_user.IN.float	{ ... }	[Scan...	user's device tags
[-] Scan_MV_ID_user.IN.float.float1	59.406998	Float	REAL	Measure value
[-] Scan_MV_ID_user.IN.float.float2	0.0	Float	REAL	user's device tags
[-] Scan_MV_ID_user.IN.float.float3	0.0	Float	REAL	user's device tags
[-] Scan_MV_ID_user.IN.float.float4	0.0	Float	REAL	user's device tags
[-] Scan_MV_ID_user.IN.float.float5	0.0	Float	REAL	user's device tags
[-] Scan_MV_ID_user.IN.float.float6	0.0	Float	REAL	user's device tags
[-] Scan_MV_ID_user.IN.float.float7	0.0	Float	REAL	user's device tags
[-] Scan_MV_ID_user.IN.float.float8	0.0	Float	REAL	user's device tags
[-] Scan_MV_ID_user.IN.float.float9	0.0	Float	REAL	user's device tags
[-] Scan_MV_ID_user.IN.float.float10	0.0	Float	REAL	user's device tags
[-] Scan_MV_ID_user.IN.string	{ ... }	[Scan...	user's device tags
[-] Scan_MV_ID_user.IN.string.string1	' '	[Scan...	Decode text

This is equivalent to the CS50 Software inspection report.

The screenshot displays a camera image with several detected features. On the left, there are five yellow circles with black outlines and a plus sign inside, representing detected blobs. On the right, there is a dashed black square outline. At the bottom left, there are two vertical red lines with small red crosses at their ends, representing detected lines. The right side of the image shows a summary table with the following data:

Inspected:	Passed:	Failed:	
109	53	56	
Process	378	Cycle	60380
Draw	23	Cycle Worst	2798716
Idle	59968	PPM	0
		PPM Worst	0
Buffers	2 of 16 used (12%)		
Overruns	None		
Measure1	59.407		✖
Decode1			✖
Count Blobs1	6		✖

Parameterize the Camera Again

The **Measure** and **Count Blob** tools can be parameterized by the PLC so they always pass. The **Decode Tool** can be parameterized so it always fails, either due to no decode, or a **Match Strings** mismatch. Scroll the tag window so **OUT.long**, **float**, and **string** are visible, then change them as shown below.

Name	Value	Style	Data Type	Description	Constant
Scan_MV_IO_user.OUT.VID	{...}	[Scan...	user's device tags when MV_demo_mode is 1 or 2.	
Scan_MV_IO_user.OUT.bool	{...}	[Scan...	user's device tags when MV_demo_mode is 1 or 2.	
Scan_MV_IO_user.OUT.int	{...}	[Scan...	user's device tags when MV_demo_mode is 1 or 2.	
Scan_MV_IO_user.OUT.long	{...}	[Scan...	user's device tags when MV_demo_mode is 1 or 2.	
Scan_MV_IO_user.OUT.long.long101	4	Decimal	DINT	Blob count must be equal to or higher than this to pass	
Scan_MV_IO_user.OUT.long.long102	6	Decimal	DINT	Blob count must be equal to or lower than this to pass	
Scan_MV_IO_user.OUT.long.long103	0	Decimal	DINT	user's device tags when MV_demo_mode is 1 or 2.	
Scan_MV_IO_user.OUT.long.long104	0	Decimal	DINT	user's device tags when MV_demo_mode is 1 or 2.	
Scan_MV_IO_user.OUT.long.long105	0	Decimal	DINT	user's device tags when MV_demo_mode is 1 or 2.	
Scan_MV_IO_user.OUT.long.long106	0	Decimal	DINT	user's device tags when MV_demo_mode is 1 or 2.	
Scan_MV_IO_user.OUT.long.long107	0	Decimal	DINT	user's device tags when MV_demo_mode is 1 or 2.	
Scan_MV_IO_user.OUT.long.long108	0	Decimal	DINT	user's device tags when MV_demo_mode is 1 or 2.	
Scan_MV_IO_user.OUT.long.long109	0	Decimal	DINT	user's device tags when MV_demo_mode is 1 or 2.	
Scan_MV_IO_user.OUT.long.long110	0	Decimal	DINT	user's device tags when MV_demo_mode is 1 or 2.	
Scan_MV_IO_user.OUT.float	{...}	[Scan...	user's device tags when MV_demo_mode is 1 or 2.	
Scan_MV_IO_user.OUT.float.float101	50.0	Float	REAL	Measure value must be higher than this to pass	
Scan_MV_IO_user.OUT.float.float102	200.0	Float	REAL	Measure value must be lower than this to pass	
Scan_MV_IO_user.OUT.float.float103	0.0	Float	REAL	user's device tags when MV_demo_mode is 1 or 2.	
Scan_MV_IO_user.OUT.float.float104	0.0	Float	REAL	user's device tags when MV_demo_mode is 1 or 2.	
Scan_MV_IO_user.OUT.float.float105	0.0	Float	REAL		
Scan_MV_IO_user.OUT.float.float106	0.0	Float	REAL		
Scan_MV_IO_user.OUT.float.float107	0.0	Float	REAL		
Scan_MV_IO_user.OUT.float.float108	0.0	Float	REAL		
Scan_MV_IO_user.OUT.float.float109	0.0	Float	REAL		
Scan_MV_IO_user.OUT.float.float110	0.0	Float	REAL		
Scan_MV_IO_user.OUT.string	{...}	[Scan...		
Scan_MV_IO_user.OUT.string.string101	'LABEL CHECK'	[Scan		
Scan_MV_IO_user.OUT.string.string102	'\$t#00#00#...	[Scan		
Scan_MV_IO_user.OUT.string.string103	' '	[Scan		
Scan_MV_IO_user.OUT.string.string104	' '	[Scan		
Scan_MV_matchcode	'LABEL CHECK'	[Scan		
Scan_MV_ons_internal	-2080374528	Decimal	DINT	0 Error(s)	



Trigger the Camera Again

Trigger the camera twice and you will see the Status results stay the same for all triggers:

bool2 (decode+matchcode status) = 0

Why: Decode + Matchcode status always fails because the matchcode has been changed to wrong code, or there is no decode.

bool1 (Measure status) and bool3 (count blob status) = 1

Why: The inspected values are now within tolerance.

InspStat = 0

Why: The Decode tool fails, so the overall Inspection result is a Fail.

PLC tags:

Name	Value	Style	Data Type	Description
[-] Scan_MV_ID_user.IN	{ ... }	[Scan_...	user's device tags
[-] Scan_MV_ID_user.IN.Status	{ ... }	[Scan_...	user's device tags
[-] Scan_MV_ID_user.IN.Status.Online	1	Decimal	BOOL	user's device tags
[-] Scan_MV_ID_user.IN.Status.ExpBusy	0	Decimal	BOOL	user's device tags
[-] Scan_MV_ID_user.IN.Status.AcqBusy	0	Decimal	BOOL	user's device tags
[-] Scan_MV_ID_user.IN.Status.TriggerReady	1	Decimal	BOOL	user's device tags
[-] Scan_MV_ID_user.IN.Status.Error	0	Decimal	BOOL	user's device tags
[-] Scan_MV_ID_user.IN.Status.ResetCountAck	0	Decimal	BOOL	user's device tags
[-] Scan_MV_ID_user.IN.Status.reserved6	0	Decimal	BOOL	user's device tags
[-] Scan_MV_ID_user.IN.Status.ExeCmdAck	0	Decimal	BOOL	user's device tags
[-] Scan_MV_ID_user.IN.Status.TriggerAck	0	Decimal	BOOL	user's device tags
[-] Scan_MV_ID_user.IN.Status.InspBusy	0	Decimal	BOOL	user's device tags
[-] Scan_MV_ID_user.IN.Status.InspStat	0	Decimal	BOOL	user's device tags
[-] Scan_MV_ID_user.IN.Status.DataValid	0	Decimal	BOOL	user's device tags
[-] Scan_MV_ID_user.IN.Status.reserved12	0	Decimal	BOOL	user's device tags
[-] Scan_MV_ID_user.IN.Status.reserved13	0	Decimal	BOOL	user's device tags
[-] Scan_MV_ID_user.IN.Status.reserved14	0	Decimal	BOOL	user's device tags
[-] Scan_MV_ID_user.IN.Status.reserved15	0	Decimal	BOOL	user's device tags
[+] Scan_MV_ID_user.IN.Status.Echo	0	Decimal	INT	user's device tags
[+] Scan_MV_ID_user.IN.Status.CmdCodeRslt	16#0000_0000	Hex	DINT	user's device tags
[+] Scan_MV_ID_user.IN.Status.CmdRet	0	Decimal	DINT	user's device tags
[+] Scan_MV_ID_user.IN.Status.reserved96_103	0	Decimal	SINT	user's device tags
[+] Scan_MV_ID_user.IN.Status.reserved104_111	0	Decimal	SINT	user's device tags
[+] Scan_MV_ID_user.IN.Status.State	1	Decimal	SINT	user's device tags
[+] Scan_MV_ID_user.IN.Status.reserved120_127	0	Decimal	SINT	user's device tags
[+] Scan_MV_ID_user.IN.VIO	{ ... }	[Scan_...	user's device tags
[-] Scan_MV_ID_user.IN.bool	{ ... }	[Scan_...	user's device tags
[-] Scan_MV_ID_user.IN.bool.bool1	1	Decimal	BOOL	measure status
[-] Scan_MV_ID_user.IN.bool.bool2	0	Decimal	BOOL	decode+matchcode
[-] Scan_MV_ID_user.IN.bool.bool3	1	Decimal	BOOL	blob count status

This concludes the EtherNet/IP demo.

Demo EtherNet/IP PLC Code

This section describes how to use di-soric demo PLC code with a vision job and camera target.

The EtherNet/IP demo files can be found where CS50 Software is installed, in the folder **C:\di-soric\Vscape\Tutorials and Samples\CS50\EIP demo**. Open the **EIP_demo.avp** with CS50 Software and download it to the camera.

During PLC integration, import the 32-000003-2.L5X file to create the camera's demo tags and ladder logic.

Notes:

- The camera communications protocol must be enabled for EtherNet/IP before it can be used in this environment. Refer to **Chapter 1, [Enabling Industrial Protocols](#)**, for information about enabling communications protocols for the CS50 Sensor, and information about switching CS50 Sensor communications protocols.
- CS50 Software jobs use di-soric Link functionality to accommodate EtherNet/IP communications between the camera and the PLC. For information about how to connect job parameters and outputs to di-soric Link tags, refer to the **di-soric Link** section of *CS50 Software Help*.

Glossary of Terms

The following terms are used in the description of di-soric's demo PLC program.

Camera

The di-soric camera used in this application, which has an EtherNet/IP communication interface.

User App

The PLC logic code written by the end user or system integrator.

Demo Code

The PLC logic code distributed by di-soric that can be imported into the PLC's ladder logic area. It encapsulates most of the device Control and Status management.

The demo code expects a demo vision job loaded on the camera. However, the demo code will operate whether or not the demo vision job is loaded on the camera.

Activate / Set High

Writing a 1 value to a single Control bit, or any other bool bit.

Active

A Control, Status, bool, or PLC logic "contact" in a 1 state.

Clear

A Control, Status, bool, or PLC logic "contact" in a 0 state.

One Shot

A PLC tag write operation that is performed once, typically in reaction to an event. After a one shot operation, the PLC logic does not write to the same tag again unless another event occurs.

Demo Setup

Vision Job Setup

The EtherNet/IP demo files can be found where CS50 Software is installed, where the default folder is **C:\di-soric\Vscape\Tutorials and Samples\CS50\EIP demo**.

1. Open **EIP_demo.avp** with CS50 Software.
2. To use pre-defined images, select the icon shown here.

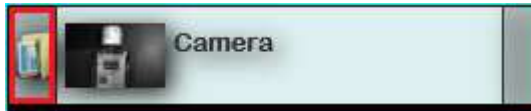

3. Browse to the **EIP demo** folder, select it, and click **OK**.

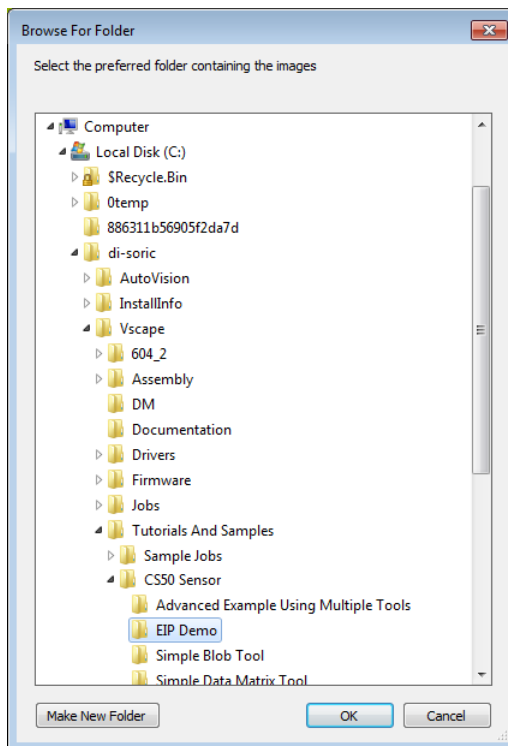

After the **EIP demo** folder has been enabled for image load, the camera icon will change to a folder.



4. While in **Edit** mode, **Try Out** can be used to get an understanding of what to expect after the job is sent to the camera.



Before Try Out can be effective, the **Measure**, **Decode**, and **Count Tool** parameters must be specified. After job download, the tool parameters will be supplied by the PLC.

Measure Tolerance:



Decode Matchstring:

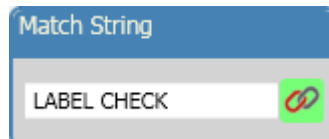







Count Tolerance:









With these tool parameter configured as shown, Try Out will show the following Pass/Fail results:

Fail:

	Measure 1 59.407	
	Decode 1	
	Count Blobs 1 6	

Pass:

	Measure 1 173.031	
	Decode 1 LABEL CHECK	
	Count Blobs 1 4	

5. Download the job to the camera.
6. Add the camera and demo code to the PLC environment (see the next section).

PLC Demo Code Setup

During PLC integration, import the **32-000003-2.L5X** file found in the **EIP demo** folder to create the camera's demo tags and ladder logic (refer to the **Allen-Bradley PLC Setup** chapters).

Description of PLC Tags

Scan_MV_demo_mode

Purpose

This tag is intended for demonstration purposes only. It modifies the operation of the demo code and allows the first-time user to control the device directly with no assistance from the demo code. It also allows the demo code to manage the Control and Status signals fully.

The demo mode tag takes three different values, putting the demo code into one of three modes of operation:

- Exchange I/O data only
- Actively operate device controls, status, and demo data
- Automatically trigger the device after one second of idle time

User App Method

User app can set the demo mode with one of three values to define the demo code's mode of operation.

0 = Exchange I/O data only

In this mode, the user directly accesses the **Scan_MV_IO_internal** tag set. The demo code only exchanges data with the camera, doing nothing to control the device or respond to events from it.

1 = Operate device controls and respond to device events

This is the default mode of the demo code. In this mode, the user app accesses the **Scan_MV_IO_user** tag to control and monitor the camera. The user app must not access the **Scan_MV_IO_internal** tag set.

In this mode, the user activates the controls in **Scan_MV_IO_user.OUT.Control** (Trigger, ResetCount, GoOnline, GoOffline, ResetError, ExeCmd), and the demo code handles the rest.

2 = Auto-trigger

In this mode, the demo code fully manages the **Control** and **Status** signals, the same as when the mode is set to **1**. It also activates the camera's trigger after one second of idle time. The timer used to drive the trigger is **Scan_MV_trigger_delay_timer**.

Demo Code Usage

Depending on the mode, the demo code will run the appropriate level of code.

- In **mode 0**, only the I/O exchange rungs are executed. All others are bypassed.
- In **mode 1**, the auto-trigger rungs are bypassed. This is the default mode of the demo code.
- In **mode 2**, all rungs are executed.

Scan_MV_IO_user

Purpose

User-accessible I/O data for the camera. The user app reads and writes these I/O tags, and the demo code handles the actual on-the-wire control of the camera.

User App Method

Activate a Control by setting its value to **1**.

The user app can determine that the Control is done when the Control is clear (demo code changes the Control to a bit/bool value of **0**). Do not attempt to activate a Control unless it is clear.

The user app should activate the Controls using one shot writes. The user app should not continuously hold a Control in an active state. Holding a Control in an active state will prevent the demo code from notifying the user app that the Control operation is complete by clearing the Control.

Usually, when a Control is clear (**0**), the camera is ready for the Control to be activated again. Please see the [Specific Control Guidelines](#) and [Specific Status Guidelines](#) below for qualifications.

Demo Code Usage

The demo code waits for the user app to activate a Control. When the user app activates a Control, the demo code handles all handshaking and confirmation that the Control operation is performed by the camera. When the operation is complete, the demo code clears the Control back to **0**.

Specific Control Guidelines

GoOnline and GoOffline

In order to take the camera **Online** and **Offline**, only one of these Controls can go active (change from **0** to **1**), and be active, at any given time.

ResetCount

After the user app activates **ResetCount**, the demo code will clear ResetCount when the operation is complete. The next Inspection output will be **1** (as can be seen if CS50 Software is connected to the camera in run mode).

Trigger

Do not trigger the camera unless the **TriggerReady Status** is active. If the Trigger goes active when TriggerReady is not active, the demo code increments the counter **Scan_MV_trigger_err_count**, and immediately clears the Trigger Control without attempting to trigger the camera.

After the user app activates the Trigger, the demo code will clear the Trigger when the camera indicates it has accepted the Trigger.

Do not re-trigger the camera until **DataValid** in the **Status** register goes active, all **Inspection** data has been processed, and DataValid is cleared using the **ResetDataValid Control**.

ResetDataValid

When the user app sees DataValid go active, it should process the Inspection data, then clear DataValid by activating **ResetDataValid**.

See [Data Valid](#) for more details.

ResetError

To clear the Error Status, activate **ResetError**.

ExeCmd, CmdCode, CmdArg

These Controls can be used to perform a job change, and query the active job slot. The demo code includes tags with pre-defined **CmdCode** and **CmdCodeRslt** definitions:

Tag	Meaning
Scan_MV_const_CmdCode_GetActiveJb	Query the active job slot number (returned in CmdRet)
Scan_MV_const_CmdCode_JbChg	Go Offline, Load job specified by LSB
Scan_MV_const_CmdCode_JbChg_MkBt	Go Offline, Load Job specified by LSB, Make it the boot job
Scan_MV_const_CmdCode_JbChg_MkBt_Online	Go Offline, Load Job specified by LSB, Make it the boot job, Go Online
Scan_MV_const_CmdCode_JbChg_Online	Go Offline, Load Job specified by LSB, Go Online
Scan_MV_const_CmdCodeRlst_Fail_No_Job	Job Change failed: No job in slot
Scan_MV_const_CmdCodeRlst_Fail_UI	PC UI is controlling the camera,
Scan_MV_const_CmdCodeRlst_Fail_Unk_Cmd	Job Change failed: Unknown CmdCode
Scan_MV_const_CmdCodeRlst_Success	Completed operation OK.

The **ExeCmd**, **CmdCode**, and **CmdArg** controls are used in combination with these Status signals:

Control signal	Status signal
ExeCmd	ExeCmdAck
CmdCode	CmdCodeRslt
CmdArg	CmdRet

The demo code records the final result of the command operation by copying **CmdCode**, **CmdArg**, **CmdCodeRslt** and **CmdRet** to the following tags:

Source Control/Status tag	Final result tag
Scan_MV_IO_user.OUT.Control.ExeCmd	Scan_MV_CmdCode_last
Scan_MV_IO_user.OUT.Control.CmdArg	Scan_MV_CmdArg_last
Scan_MV_IO_internal.IN.Status.CmdCodeRslt	Scan_MV_CmdCodeRslt_last
Scan_MV_IO_internal.IN.Status.CmdRet	Scan_MV_CmdRet_last

The demo code will automate the command process when **Scan_MV_demo_mode** is **1**, which is the default value at program startup, similar to how it assists the Triggering and DataValid Controls. The PLC integrator can initiate command operation by accessing the demo code's **Scan_MV_IO_user** tag set for Control and Status signals. While a command operation is active, the demo code forces all Control signals to an inactive state, except for the Echo. No Controls can be activated until the command operation is completed. To verify the camera is still "alive" during command execution, **Control.Echo** can be incremented, and the **Status.Echo** will update accordingly.

When the demo code automates the command process, the PLC integrator is responsible for the following steps:

1. Deactivate all Controls and clear DataValid and Error status signals. This is a best-practice measure to ensure that the PLC has transitioned from a state of triggering and processing inspections to issuing a command.
2. If a job change command is to be issued, populate the output tags required to configure the new job (**bool**, **int**, **long**, **float**, **string**).
3. Write the required **CmdCode** (see **Scan_MV_const_CmdCode_xxxx** tags) and **CmdArg**, then activate **ExeCmd**.
4. Wait for **ExeCmd** to go inactive (per typical demo mode **1** operation). Note that job changes can take up to a minute. While a job change command is being executed, the **Status.State** tag will be **2**.
5. When **ExeCmd** goes inactive, verify the following:

Scan_MV_CmdCodeRslt_last is **0** (Success)

Scan_MV_CmdRest_last contains the returned data from the command (if any)

Status.State has changed to **0** (Offline) or **1** (Online)

ExeCmdAck is inactive (**0**)

Status.Error is inactive (**0**)

6. Put the camera online (if necessary), and continue with normal runtime operation.

Specific Status Guidelines

Online

The camera cannot be Triggered or generate Inspection data unless **Online** is active. See the **GoOnline Control**.

TriggerReady

Do not attempt to trigger the camera unless **TriggerReady** is active.

See the description of the **Trigger** for more details.

TriggerAck and ResetCountAck

Used by the demo code to complete the respective operations.

DataValid

When **DataValid** goes active, the user app should process the Inspection data, then clear DataValid using the **ResetDataValid** control. This is handled, by the demo code in mode **1** and **2**, as a demonstration for the user app.

If the camera's DataValid goes active, but the user app has not cleared a previous DataValid event, the demo code does not overwrite **Scan_MV_IO_user** with new Inspection data. Instead, the demo code increments the counter **Scan_MV_dv_err_count**. The new Inspection data remains stranded in the **Scan_MV_internal** tag set, and is effectively lost.

Scan_MV_trigger_count

Incremented by the demo code when a new trigger is issued to the camera over the EtherNet/IP interface (Trigger Control activated).

Scan_MV_trigger_err_count

Incremented by the demo code if the user app attempts to trigger the camera when TriggerReady is not active.

Scan_MV_dv_err_count

Incremented by the demo code when new Inspection data is received from the camera, but the user app has not cleared the previous DataValid.

Scan_MV_status_err_count

Incremented by the demo code whenever the Error Status goes active.

Scan_MV_demo_blob, Scan_MV_demo_decode, Scan_MV_demo_InspStat, Scan_MV_demo_measure

Purpose

These tags record counts and min and max values of several EIP IN data members.

The demo code expects a demo vision job to be loaded on the camera, and a demo target to be in the camera's field of view. The demo PLC code will operate without the demo vision job being loaded on the camera. However, the data records will not be valid.

The demo vision job has the following data members linked to certain job tools:

IN

Bool1 = Measure status (pass/fail)

Bool2 = Decode+Matchcode status (pass/fail)

Bool3 = Blob count status (pass fail)

Long1 = Blob count

Float1 = Measure value

String1 = Decode text

OUT

Long101 = Blob count minimum count tolerance

Long102 = Blob count maximum count tolerance

Float101 = Measure lower tolerance

Float102 = Measure upper tolerance

String101 = Matchcode

Each tag set records the following data for each vision job tool result received in the Inspection report:

Tool Result	Record tag	EIP IN tag
Measurement Status	Scan_MV_demo_measure. bool = last status(pass/fail) pass_count = count of passes fail_count = count of fails	Scan_MV_user_IN.bool.bool1
Measurement	Scan_MV_demo_measure. float = last value float_max = max value recorded float_min = minimum value recorded	Scan_MV_user_IN.float.float1
Decode Text Status (matchcode)	Scan_MV_demo_decode bool = last status(pass/fail) pass_count = count of passes fail_count = count of fails	Scan_MV_user_IN.bool.bool2
Decode Text	Scan_MV_demo_decode string = text of the last barcode decode attempt (null if noread)	Scan_MV_user_IO.string.string1
Blob Status	Scan_MV_demo_blob bool = last status(pass/fail) pass_count = count of passes fail_count = count of fails	Scan_MV_user_IN.bool.bool3
Blob Count	Scan_MV_demo_blob long = last value long_max = max value recorded long_min = minimum value recorded	Scan_MV_user_IN.long.long1

User App Method

The user app can follow the demo code's usage of these tags for further application logic development.

During runtime, the user app can change the OUT data members, and observe the change in tool status after a new trigger.

Specifically, the PLC integrator would typically modify the logic beginning at the following rungs:

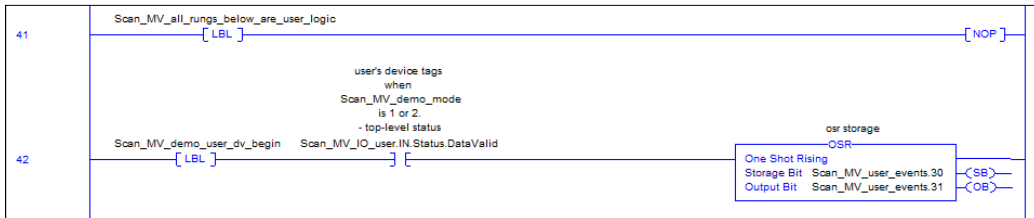

Demo Target

The demo vision job uses predefined images. It is unnecessary to have the camera aimed at any specific target. If preferred, the job can be changed to enable the camera's image sensor. In this case, the demo targets should be printed approximately **2.5 inches (63 mm)** wide by **1.6 inches (40 mm)** tall, centered on white paper larger than the camera's field of view, and presented to the camera with the Data Matrix symbol on the right:

“Pass” Image

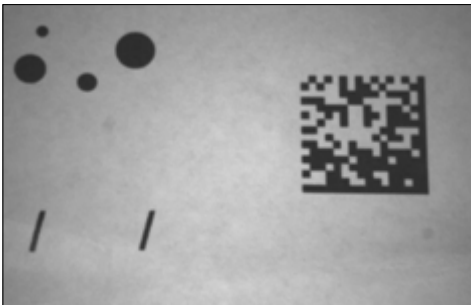

“Fail” Image

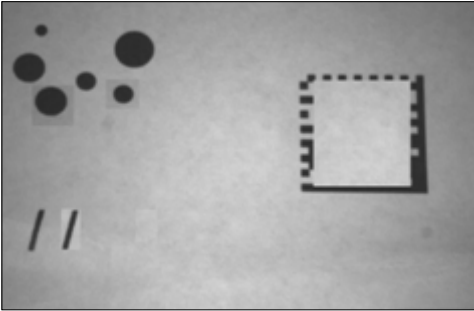

Demo Code Usage

The user app example of the demo code watches for Data Valid. When it goes active, the user app example processes the user I/O data, updates each demo record with the results, then uses **ResetDataValid** to clear DataValid.

Scan_MV_IO_internal, Scan_MV_ons_internal

Purpose

Used by the demo code to manage the camera.

User App Method

None. The user app must not attempt to read or write to this tag set.

Demo Code Usage

The demo code uses this tag set to abstract the on-the-wire control of the camera from the user app.

Run the Camera: Runtime Operation of EtherNet/IP Demo

At this point in the evaluation, it is assumed that you have downloaded the demo vision job to the camera and that your PLC is running the EtherNet/IP demo code and exchanging data with the camera. The PLC can now parameterize, trigger and monitor the camera over EtherNet/IP.

Omron PLC Setup for EtherNet/IP Operation

This section describes how to set up an Omron PLC for EtherNet/IP operation using a CS50 Sensor and CX-One software.

Notes:

- The camera communications protocol must be enabled for EtherNet/IP before it can be used in this environment. Refer to **Chapter 1, [Enabling Industrial Protocols](#)**, for information about enabling communications protocols for the CS50 Sensor, and information about switching CS50 Sensor communications protocols.
- CS50 Software jobs use di-soric Link functionality to accommodate EtherNet/IP communications between the camera and the PLC. For information about how to connect job parameters and outputs to di-soric Link tags, refer to the **di-soric Link** section of *CS50 Software Help*.

Setting Up an Omron PLC

This section was created using the following Omron software and hardware:

- CX-Programmer version 9.43
- Network Configuration version 3.55
- PLC CJ2M CPU31

Start the CX-Programmer application and select menu item **File > New**. Enter the desired **Device Name**. Select the **Device Type** and then click **Settings** to the right of the Device Type menu.

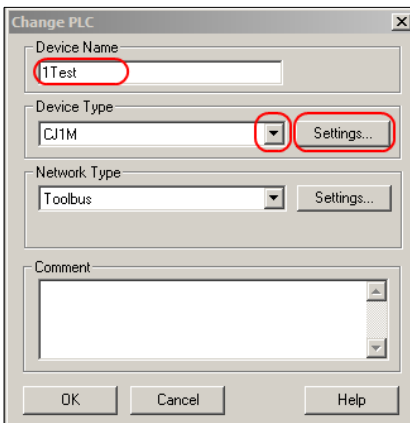

In the **Device Type Settings** dialog, select the correct **CPU Type** and click **OK**.

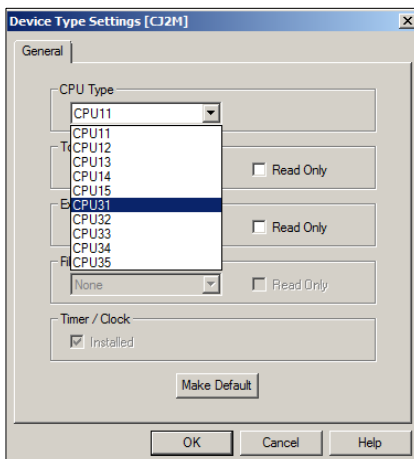

Select **USB** from the **Network Type** menu and click **OK**.

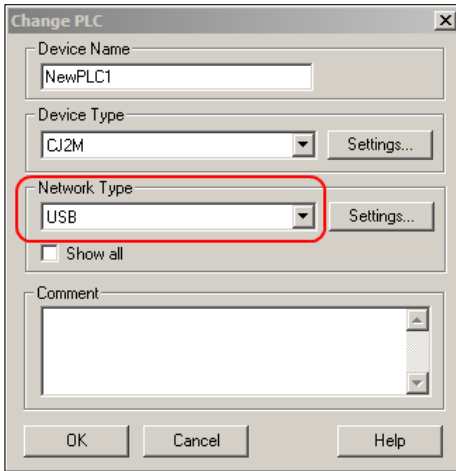

Connect to the PLC via USB connection. Select the menu item **PLC > Work Online** or click the online icon in the tool bar. When prompted, click **Yes** to complete the connection.

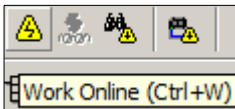

Once successfully connected, the background of the right pane will turn gray and the online icons in the ribbon will remain clicked.

To complete the next steps the PLC must be in **Program Mode**. Right-click the PLC node in the tree view in the left pane and select **Operating Mode > Program**.

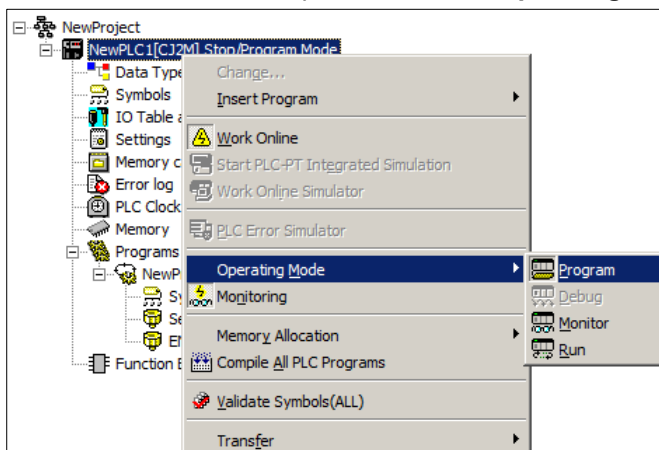

To register the I/O table, double-click **IO Table and Unit Setup**.

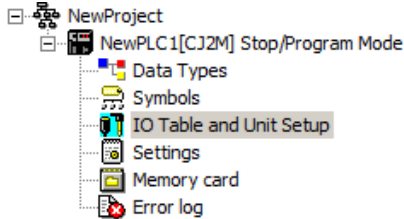

Select **Options > Create**.

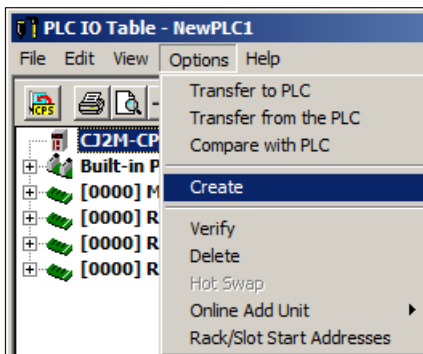

Click **Yes** at the I/O table creation prompt. Click **Yes** at the Initialize CPU bus settings prompt. Click **Transfer** at the transfer prompt. Click **OK** at the results prompt. The IO table will now be updated with the current PLC hardware settings.

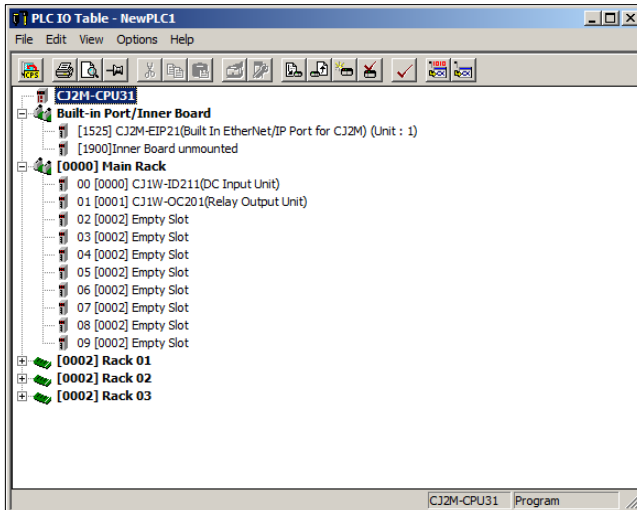

To edit the EtherNet/IP items and mapping, double-click the EtherNet/IP node.

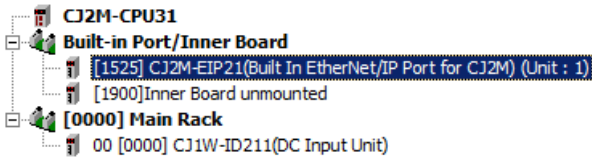

Input the desired IP settings and then click **Transfer [PC to Unit]**.

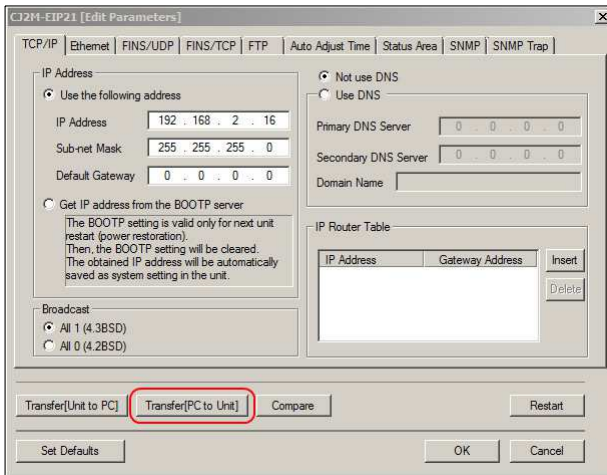

When prompted to transfer, click **Yes**. After the transfer prompt click **Close**. When prompted to restart the unit click **Yes**. Once the unit resets, click **OK** at the prompt. Close the IO edit dialog.

Physically power down the unit and adjust the rotary switches to match the last octet of the new IP address from above. Then power the unit back on.



Set the CX-Programmer application to offline by selecting **PLC > Work Offline** or the online icon in the ribbon.

In the CX-Programmer application, double-click the PLC node. In the Network Type menu, select **EtherNet/IP**. Click **Settings** to the right of Network Type and enter the PLC's new IP address. Click the **OK** buttons to close the dialogs.

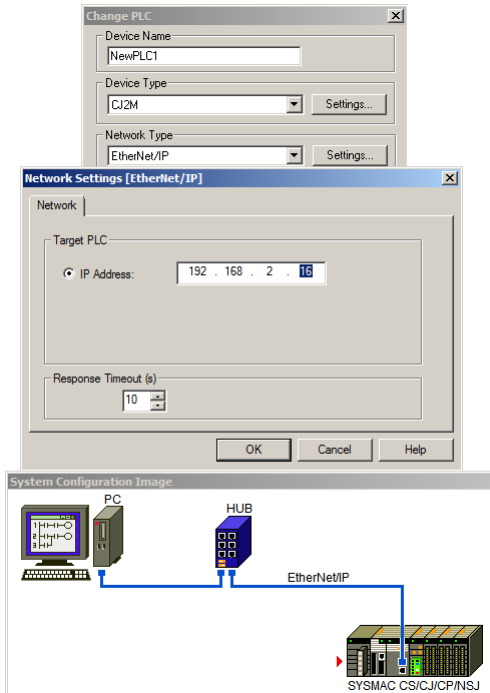

Set the CX-Programmer back to online. You will be prompted with a connection via EtherNet/IP. Click **Yes** to complete the connection.

Double-click the **IO Table and Unit Setup** node. Expand the **Built-In Port/Inner Board** node. Right-click and select **Start Special Application > Start with Settings Inherited**.

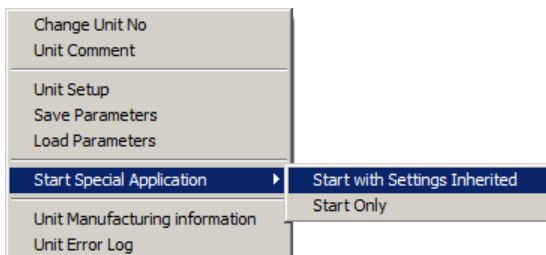

Select **Network Configurator** and click **OK**. Select port **TCP:2** and click **OK**. Then click **OK** for **EtherNet/IP_1** connection.

To install the EDS file, select **EDS File > Install**. Navigate to the EDS folder **C:\di-soric\Vscape\Firmware\eds\CS50**. Select the correct file and click **Open** to load the file. All other EDS files can be downloaded from www.di-soric.com.

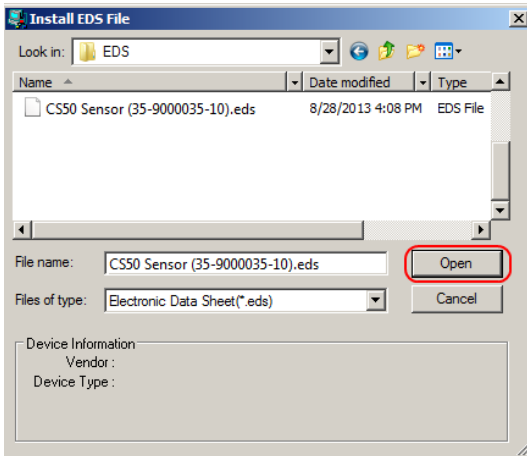

Expand the left tree view to open the **OMRON Corporation** files. Locate **CJ2M-EIP21** for this example and drag it to the line in the right pane.

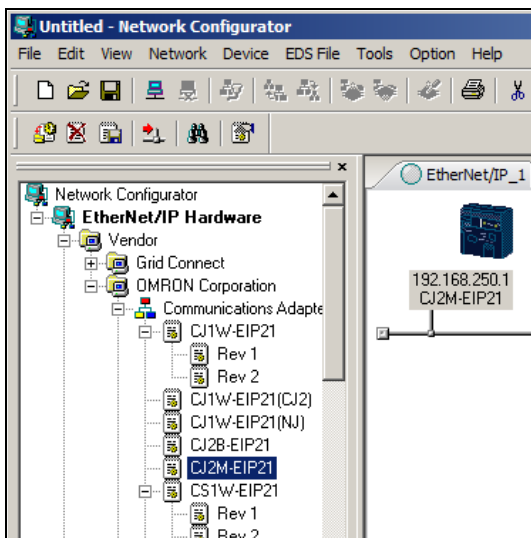

Expand the **Vendor Collection** node for the camera connected to the PLC and drag it to the line in the right pane.

Right-click near the newly-added icons and select **Change IP Address**. Enter the IP address for the PLC and the camera or reader attached and click **OK**.

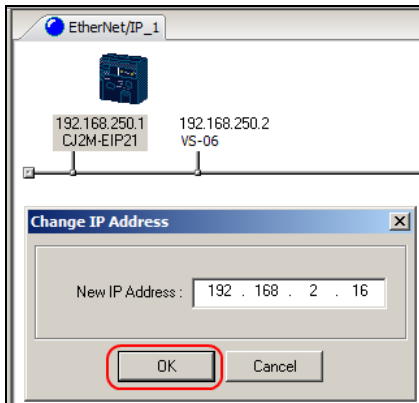

Double-click the PLC icon to edit the device parameters. This is where you will be linking and mapping the EtherNet/IP assembly data to the internal memory of the PLC. Select the **Tag Sets** tab. Select the **In - Consume** tab at the top. Click **Edit Tags** below. Then click **New** to edit/create a new tag. In this example we are naming this tag **300** for the peripheral memory linked to the input data. Select the size (**320 bytes**) for the entire input assembly. Click **Register** then **Close** to continue.

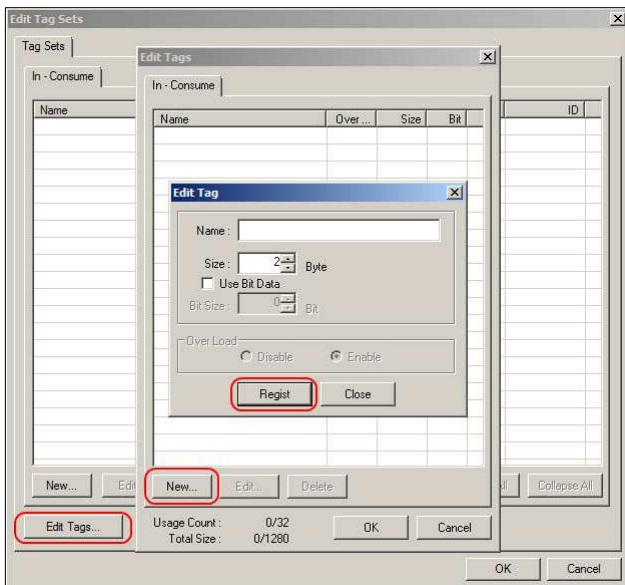

Select the **Out - Produce** tab and then click **New**. For the output assembly you are going to map to peripheral memory address **500** with **320 bytes**. Click **Register** and then **Close**. Click **OK** on the **Edit Tags** dialog. When prompted to register new tags click **Yes**.

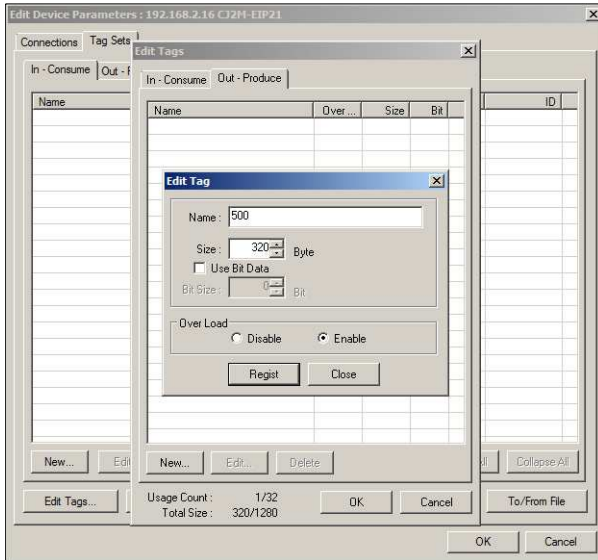

Click the **Connections** tab on the **Edit Device Parameters** dialog. Click the download button in the middle to register the device.

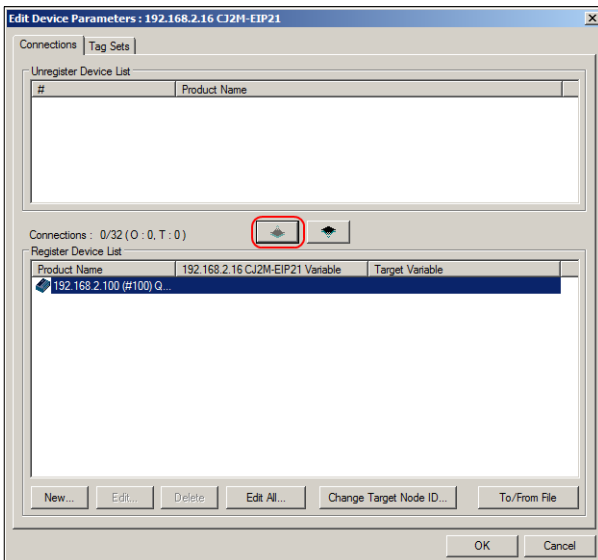

In the lower pane, double-click the PLC in the registered device list. This will open the linking dialog. If there are multiple connection types, they can be selected from the **Connection I/O Type** menu. In the **Originator Device** section, select the **Input Tag** then the **Output Tag**. Adjust the RPI if needed. When done, click **Register** and then **Close**.

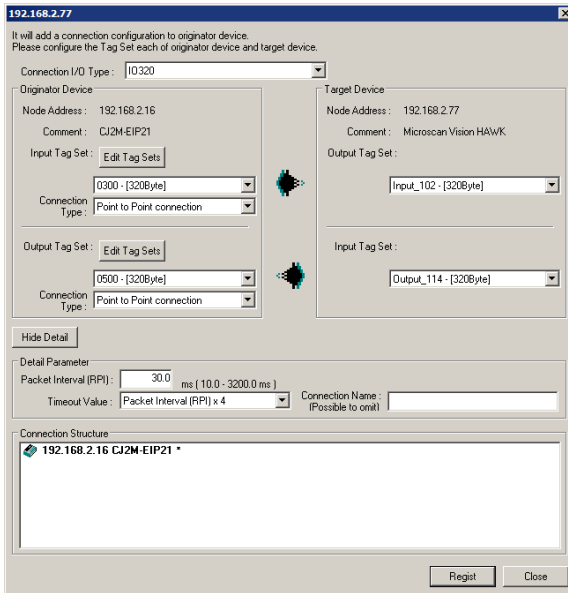

The registered device will now display the tags that are linked. Click **OK** to continue.

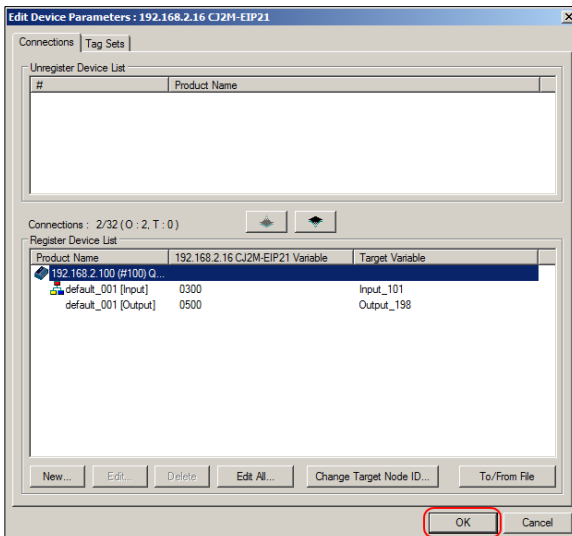

Download the new tags and links to the PLC by selecting **Device > Parameter > Download** or by clicking the download icon in the ribbon. Click **Yes** when prompted to download.



When the **List of Devices That Are Executing** dialog appears, select the PLC and click **Download after Changed to Program Mode**. When prompted to return the state, click **Yes** to continue.

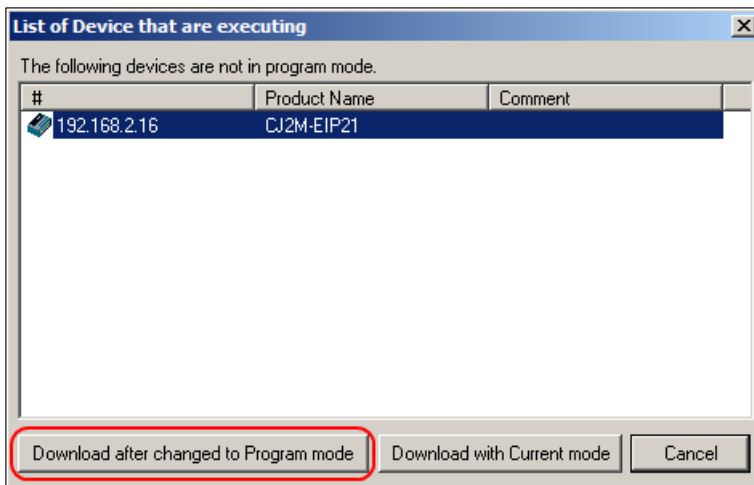

Select **Network > Check Connection** in the Network Configurator to ensure that there are no connection problems.

Using PROFINET I/O

This section provides information necessary for using the CS50 Sensor in a PROFINET I/O environment.

Notes:

- The camera communications protocol must be enabled for PROFINET I/O before it can be used in this environment. Refer to **Chapter 1, [Enabling Industrial Protocols](#)**, for information about enabling communications protocols for the CS50 Sensor, and information about switching CS50 Sensor communications protocols.
- CS50 Software jobs use di-soric Link functionality to accommodate PROFINET I/O communications between the camera and the PLC. For information about how to connect job parameters and outputs to di-soric Link tags, refer to the **di-soric Link** section of *CS50 Software Help*.

Important: PROFINET I/O allows the IP address and subnet mask of the CS50 Sensor to be assigned automatically by the PLC. In order to allow this, the CS50 Sensor may not have an assigned IP address on reboot until the PLC is set to Run mode. During this time, the CS50 Sensor will not be visible on the network for CS50 Software.

CS50 Sensor PROFINET I/O

PROFINET I/O Identity

Vendor ID

di-soric's Vendor ID is **0x221**.

Device ID

The Device ID is **0x7000**.

Connection Properties: RT Cyclic Messaging

Odd slot numbers are input to the PLC, even slot numbers are output from the PLC.

Maximum data size in either direction is 518 bytes. The data size can be reduced by removing slots that are not used.

Cycle update time: 16ms

Slot/Subslot Layout Descriptions

Slot	Dir	Bytes	Name	Description
1	In	2	STATUS	Status register of the camera, each bit of this register represents a different state item. See Camera Status Register for bit descriptions
3	In	2	ECHO	This 16 bit word value reflects back to the PLC the value that the PLC wrote to the output assembly ECHO register. The PLC can verify the output assembly has been written to the camera when this value matches the written value.
5	In	4	CmdCodeRslt	When Status.ExeCmdAck goes active in response to Control.ExeCmd, CmdCodeRslt reflects the result of the command invoked by Control.CmdCode. See CmdCodeRslt for definitions.
7	In	4	CmdRet	When Status.ExeCmdAck goes active in response to Control.ExeCmd, CmdRet contains the data returned from the command invoked by Control.CmdCode. See CmdRet for definitions.
9	In	2	State	Device State register. Depending on the current state of the camera, certain STATUS and CONTROL features may or may not be operational. See State for

				definitions.
2	Out	2	CONTROL	Control register of camera. Each bit of this register represents a different status item. See <i>Camera Control Register</i> for bit descriptions
4	Out	2	ECHO	This 16 bit value is reflected back to the PLC in the input assembly ECHO register. The PLC can verify the output assembly has been written to the camera when the input assembly matches this written value.
6	Out	4	CmdCode	Specifies the process invoked in the camera when Control.ExeCmd goes active. See <i>CmdCode</i> for definitions.
8	Out	4	CmdArg	Additional argument data for the CmdCode. See <i>CmdArg</i> for definition.
11	In	2	VIO	Each bit reflects the state of a virtual IO point. The least significant bit reflects vio point 145, the most significant bit vio point 160
10	Out	2	VIO	Each bit reflects the state of a virtual IO point. The least significant bit reflects vio point 129, the most significant bit is vio point 144
13	In	8	bool1-64	Each bit represents a bool value. The least significant bit of byte 0 reads the value of bool1. The most significant bit of byte 7 reads bool64.
12	Out	8	Bool101-164	Each bit represents a bool value. The least significant bit of byte 0 writes the value of bool101. The most significant bit of byte 7 writes bool164.
15	In	20	int1-10	Each pair of sequential bytes represents a 16 bit signed integer value. The 20 bytes represent 10 integers. From bytes 0-1 for the value of int1 through bytes 18-19 for the value of int10.

14	Out	20	int101-110	Each pair of sequential bytes represents a 16 bit signed integer value. The 20 bytes represent 10 integers. From bytes 0-1 to write the value of int101 through bytes 18-19 for the value of int110.
17	In	64	long1-16	Each group of 4 bytes represents a 32 bit signed integer value. The 64 bytes represent 16 long integers. From bytes 0-3 for the value of long1 through bytes 60-63 for the value of long16.
16	Out	64	long101-116	Each group of 4 bytes represents a 32 bit signed integer value. The 64 bytes represent 16 long integers. From bytes 0-3 for the value of long101 through bytes 60-63 for the value of long116.
19	In	96	float1-24	Each group of 4 bytes represents a 32 bit signed integer value. The 96 bytes represent 24 long integers. From byte offsets 0-1 for the value of float1 through byte offsets 92-95 for the value of float24.
18	Out	96	float101-124	Each group of 4 bytes represents a 32 bit signed integer value. The 96 bytes represent 24 long integers. From bytes 0-3 for the value of float101 through bytes 92-95 for the value of float124.
21	In	96	string1	These 96 bytes can store a string of up to 94, 8 bit characters, with the first 2 bytes containing the storage length and string length values.
20	Out	96	string101	These 96 bytes can store a string of up to 94, 8 bit characters, with the first 2 bytes containing the storage length and string length values.
23	In	96	string2- string7	6 consecutive strings, each of 32 bytes can store a string of up to 30, 8 bit characters, with the first 2 bytes of each string group containing the storage length and string length values.
22	Out	96	string102- string107	6 consecutive strings, each of 32 bytes can store a string of up to 30, 8 bit characters, with the first 2 bytes of each string group containing the storage length and string length values.

Slot Data Layout Diagrams

PLC Input

Slot	Byte Offset	Data
1	0	STATUS
3	0	Echo In
5	0	CMD CODE RSLT
7	0	CMD RET
9	0	STATE
11	0	VIO 145.. 160
13	0	bool 1.. 16
	2	bool 17.. 32
	4	bool 33.. 48
	6	bool 49.. 64
15	0	int 1
	2	int 2
	4	int 3
	6	int 4
	8	int 5
	10	int 6
	12	int 7
	14	int 8
	16	int 9
	18	int 10
17	0	long 1
	4	long 2
	8	long 3
	12	long 4
	16	long 5
	20	long 6
	24	long 7
	28	long 8
	32	long 9
	36	long 10
	40	long 11
	44	long 12
	48	long 13
	52	long 14
	56	long 15
	60	long 16

PLC Output

Slot	Byte Offset	Data
2	0	CONTROL
4	0	Echo Out
6	0	CMD CODE
8	0	CMD ARG
10	0	VIO 129.. 144
12	0	bool 101.. 116
	2	bool 117.. 132
	4	bool 133.. 148
	6	bool 149.. 164
14	0	int 101
	2	int 102
	4	int 103
	6	int 104
	8	int 105
	10	int 106
	12	int 107
	14	int 108
	16	int 109
	18	int 110
16	0	long 101
	4	long 102
	8	long 103
	12	long 104
	16	long 105
	20	long 106
	24	long 107
	28	long 108
	32	long 109
	36	long 110
	40	long 111
	44	long 112
	48	long 113
	52	long 114
	56	long 115
	60	long 116

PLC Input

Slot	Byte Offset	Data
19	0	float 1
	4	float 2
	8	float 3
	12	float 4
	16	float 5
	20	float 6
	24	float 7
	28	float 8
	32	float 9
	36	float 10
	40	float 11
	44	float 12
	48	float 13
	52	float 14
	56	float 15
	60	float 16
	64	float 17
	68	float 18
	72	float 19
	76	float 20
	80	float 21
	84	float 22
	88	float 23
	92	float 24

PLC Output

Slot	Byte Offset	Data
18	0	float 101
	4	float 102
	8	float 103
	12	float 104
	16	float 105
	20	float 106
	24	float 107
	28	float 108
	32	float 109
	36	float 110
	40	float 111
	44	float 112
	48	float 113
	52	float 114
	56	float 115
	60	float 116
	64	float 117
	68	float 118
	72	float 119
	76	float 120
	80	float 121
	84	float 122
	88	float 123
	92	float 124



























PLC Input

Slot	Byte Offset	Data
21	0	94
	1	<str 1 len>
	2	string 1
	95	
23	0	30
	1	<str 2 len>
	2	string 2
	31	
	32	30
	33	<str 3 len>
	34	string 3
	63	
	64	30
	65	<str 4 len>
	66	string 4
	95	
	96	30
	97	<str 5 len>
	98	string 5
	127	
160	30	
161	<str 6 len>	
162	string 6	
191		

PLC Output

Slot	Byte Offset	Data
20	0	94
	1	<str 101 len>
	2	string 101
	95	
22	0	30
	1	<str 102 len>
	2	string 102
	31	
	32	30
	33	<str 103 len>
	34	string 103
	63	
	64	30
	65	<str 104 len>
	66	string 104
	95	
	96	30
	97	<str 105 len>
	98	string 105
	127	
160	30	
161	<str 106 len>	
162	string 106	
191		

STEP 7 PLC Slot Layout

Slot	Module	Order number	I address	Q address	Diagnostic address:
0	 PS 307 5A				2041*
X7	 CP 343-1				2040*
X7.1	 CP 343-1				2039*
1	 PS 307 5A		10...11		
2	 PS 307 5A			0...1	
3	 PS 307 5A		540...541		
4	 PS 307 5A			264...265	
5	 PS 307 5A		532...535		
6	 PS 307 5A			260...263	
7	 PS 307 5A		536...539		
8	 PS 307 5A			256...259	
9	 PS 307 5A		542		
10	 PS 307 5A			11...12	
11	 PS 307 5A		12...13		
12	 PS 307 5A			3...10	
13	 PS 307 5A		2...9		
14	 PS 307 5A			362...381	
15	 PS 307 5A		352...371		
16	 PS 307 5A			382...445	
17	 PS 307 5A		372...435		
18	 PS 307 5A			266...361	
19	 PS 307 5A		256...351		
20	 PS 307 5A			446...541	
21	 PS 307 5A		436...531		
22	 PS 307 5A			542...733	
23	 PS 307 5A		543...734		

Status: Camera Status Register (16-bit)

Each bit of this register represents a signal that displays the camera's operational status. A high value of **1** indicates that the signal is **active** (true).

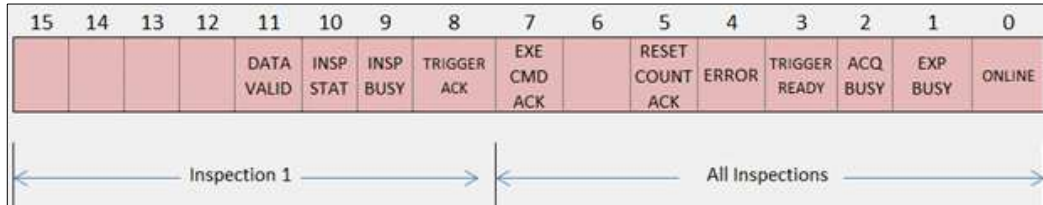

Bit	Name	Description
0	ONLINE	Inspections are running
1	EXP BUSY	The camera is busy capturing an image. The camera should not be triggered or the part under inspection moved during this time if illuminated.
2	ACQ BUSY	The camera is busy acquiring an image. The camera cannot be triggered while busy.
3	TRIGGER READY	The camera is ready to be triggered. This is equivalent to $ONLINE == 1$ and $ACQ BUSY == 0$.
4	ERROR	An error has occurred. Set the RESET ERROR control bit high to clear.
5	RESET COUNT ACK	This bit mirrors the RESET COUNT control bit. The PLC can be certain the reset command was received by the camera when this goes high. The PLC can then bring the RESET COUNT control signal back low.
7	EXE CMD ACK	This bit mirrors the EXE CMD control bit.
8	TRIGGER ACK	This bit mirrors the TRIGGER control bit.
9	INSP BUSY	This bit is high when inspection 1 is busy processing an image.
10	INSP STAT	This bit represents the inspection 1 status result. It is 1 if the inspection passes. It is only valid when DataValid goes high.
11	DATA VALID	This bit goes high when inspection 1 is complete. The PLC should clear this signal by setting RESET DV high once it has read results.

CmdCodeRslt (32-bit)

The value of **CmdCodeRslt** is only valid when **ExeCmdAck** is active (1), in response to **ExeCmd** being active.

CmdCodeRslt value	Meaning
(base 16 hex)	
0x0000_0000	Success
0x0100_0000	Fail. Possible reasons: Camera under PC control. Job cannot be changed.
0x0200_0000	Fail: No Job in slot.
0x0300_0000	Fail: Unknown cmd.

CmdRet (32-bit)

The value of **CmdRet** is only valid when **ExeCmdAck** is active (1), in response to **ExeCmd** being active, and **CmdCodeRslt** is 0 (Success). The following chart shows which **CmdCodes** return data in the **CmdRet** register.

CmdRet value	Associated CmdCode	Meaning
(32 bit)		
0	0x1000_0000 to 0x1300_0000 (Job Change type)	Na
1 – 255	0x1800_0000 (Query Active Job Slot)	Active Job Slot #

State (16-bit)

State reflects the following operational condition of the camera:

State value	Meaning	Typical action required by the client (PLC), or system operator
(16 bit)		
0	Offline	Perform job change or put camera online.
1	Online	Normal runtime operation: Monitor TriggerReady and DataValid signals. Trigger the camera.
2	Changing Vision Job	<p>If camera is under pc control: Wait until State changes to Offline or Online.</p> <p>If PLC is controlling the job change: Use ExeCmd, CmdCode, ExeCmdAck, and CmdCodeRslt to complete the operation.</p>
3	Booting*	Wait for camera to transition to Online or Offline.
4	Empty (no Vision Job)	Load a new job from AutoVISION or Front Runner.

*Booting (3) State: This will rarely be seen by the PLC.

The value of State determines which Control and Status signals are available:

Control/Status Signal	State				
	0 (Offline)	1 (Online)	2 (Job Change)	3 (Booting)	4 (Empty)
Control.GO ONLINE	Y				
“.GO OFFLINE		Y			
“.RESET ERROR					
“.RESET COUNT	Y	Y			
“.EXE CMD	Y	Y	Y		Y
“.TRIGGER		Y			
“.RESET DATA VALID		Y			
Status.ONLINE	Y	Y	Y	Y	Y
“.ERROR					
“.RESET COUNTACK	Y	Y			
“.EXE CMD ACK	Y	Y	Y		Y
“.EXP BUSY		Y			
“.ACQ BUSY		Y			
“.TRIGGER READY		Y			
“.TRIGGERACK		Y			
“.INSP BUSY		Y			
“.INSP STAT		Y			
“.DATA VALID		Y			

Where:

Y= Signal is valid for this State

Empty cell = Signal is not valid for this State

VIO Output Register Bits

15	14	13	12	11	10	9	8	7	6	5	4	3	2	1	0
v144	v143	v142	v141	v140	v139	v138	v137	v136	v135	v134	v133	v132	v131	v130	v129

VIO Input Register Bits

15	14	13	12	11	10	9	8	7	6	5	4	3	2	1	0
v160	v159	v158	v157	v156	v155	v154	v153	v152	v151	v150	v149	v148	v147	v146	v145

Control: Camera Control Register (16-bit)

Each bit of this register controls a function on the camera. Transitions from a low state of **0** to a high state of **1** initiate the associated operation. The PLC should return the state of the control bit back to **0** after it has acknowledged the camera has processed the control. Unused bits should remain **0**.

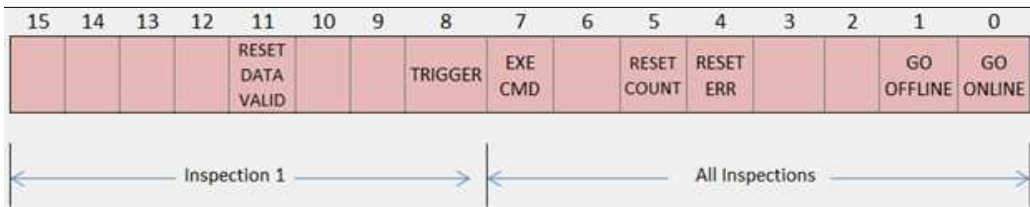

Bit	Name	Description
0	GO ONLINE	Start all inspections running
1	GO OFFLINE	Stop all inspections
4	RESET ERROR	Reset ERROR in the Status register
5	RESET COUNT	Reset all inspection counts
7	EXE CMD	Execute the command specified by Control.CmdCode
8	TRIGGER	Trigger Inspection 1. The inspection must be configured for a triggered image acquisition.
11	RESET DATA VALID	Reset the Data Valid signal of the Status register

CmdCode and CmdArg (32-bit)

Specifies the process invoked in the camera when **Control.ExeCmd** goes active.

List of Available CmdCodes and Associated CmdArg

CmdCode value	CmdArg	Operations performed
0x1000_0000	Job Slot (1-255)	Go Offline, Load job from specified slot
0x1100_0000	Job Slot (1-255)	Go Offline, Load job from specified slot, Go Online
0x1200_0000	Job Slot (1-255)	Go Offline, Load job from specified slot, Make it the boot job
0x1300_0000	Job Slot (1-255)	Go Offline, Load job from specified slot, Make it the boot job, and Go Online
0x1800_0000	na	Query active job slot. <u>CmdRet</u> will contain the active job slot number when the operation is done.

CmdCode and ExeCmd Operation

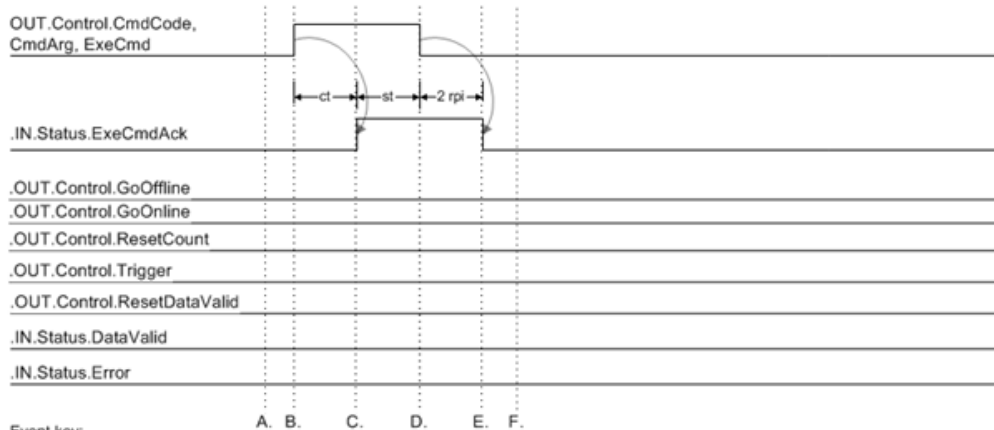

Event key:

A. If DataValid or Error are present, clear them.

Set the following control signals idle, and keep them idle while the command is processed by the camera:

GoOffline, GoOnline, Trigger, ResetDataValid, ResetCount, ResetError.

If the command operation is a job change, populate the output tags required to configure the new job (bool, int, long, float, string).

B. Populate CmdCode and CmdArg, then activate ExeCmd.

C. Camera executes the command (may take up to a minute). While processing a Job Change command, State will be 2. Camera activates ExeCmdAck when it is done processing the command.

D. When the PLC sees an active ExeCmdAck, verify CmdCodeRslt is 0, and Error is 0. Process CmdRet if needed, then clear ExeCmd.

E. Camera clears ExeCmdAck when ExeCmd goes inactive. When ExeCmdAck goes inactive, CmdCodeRslt and CmdRet are no longer valid, and it may take a few seconds for the camera State and Online signals to settle to a final value (typically Online or Offline).

F. Camera can now be put online and triggered.

Notes:

st = PLC program scan time

ct = Command processing time in the camera. May take up to a minute for some commands.

rpi = Requested Packet Interval. Configured in the plc's EIP module connection properties. Allowed rpi is 10 ms to 3.2 s.

All signals represent the state of plc tags.

PROFINET I/O Control/Status Signal Operation

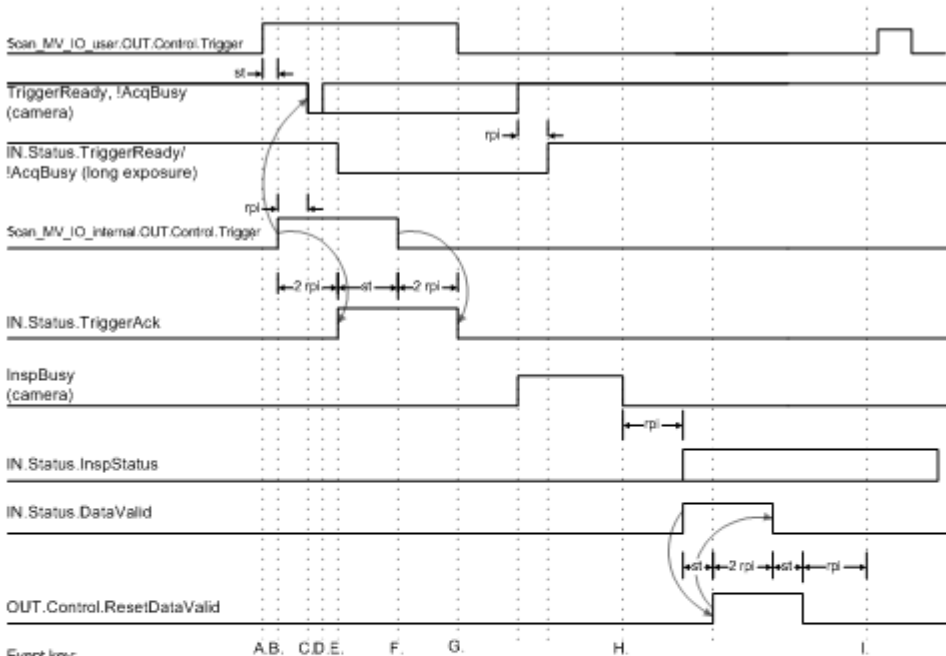

Event key:

- On rising edge of system trigger, the user app activates `Scan_MV_IO_user.OUT.Control.Trigger` to trigger the demo code.
- Demo code detects rising edge of `Scan_MV_IO_user.OUT.Control.Trigger`, and if the camera is ready, sends a trigger to the camera.
- Camera acquisition begins (may be delayed by one `rpi`).
- If the camera's exposure time is shorter than the `rpi`, no change will be seen in `TriggerReady` and `AcqBusy` plc IN tags.
- Camera firmware acks the trigger. The demo code may not see the ack until two `rpi` after the trigger was sent (event B).
- Demo code detects `TriggerAck` and clears the `Trigger`.
- Demo code detect falling edge of `TriggerAck` and clears the user `Trigger`.
- Camera internal signal `DataValid` will go high when `InspBusy` goes low
- Plc logic must delay one `rpi` time before re-asserting `ResetDataValid`

Notes:

- The chart shows the workings of the `Trigger` and `ResetDataValid` Control signals, and the `TriggerAck` and `DataValid` Status signals.
- `st` = plc program scan time
- `rpi` = Requested Packet Interval. Configured in the plc's EIP module connection properties. Allowed `rpi` is 10 ms to 3.2 s.
- All signals represent the state of plc tags, except where noted as "(camera)". The cam signals shown are visible in the EIP interface, but the state of the plc tags and internal firmware signals will be different for at least one or two requested packet intervals (`rpi`).
- The plc is running the demo code distributed with the camera. The demo code and user app use the `Scan_MV_IO_user` tag set as the primary control, status, and data interface for the user app. All signal operations are still true even if the plc demo code is not used.
- `TriggerReady/!AcqBusy`: Camera exposure times can range from less than 1 ms, up to 100 ms.

PROFINET I/O Blob Count Demo Using TIA Portal V13 and CS50 Sensor

This section describes how to use di-soric demo PLC code with a vision job and camera target. The PROFINET I/O demo files can be found where CS50 Software is installed, in the folder: **C:\di-soric\Tutorials and Samples\CS50 Sensor\PROFINET demo\TIAPortal_Demos\BlobDemo**. Open **Blob_Demo.avp** with CS50 Software and download them to the camera.

Notes:

- The camera communications protocol must be enabled for PROFINET I/O before it can be used in this environment. Refer to **Chapter 1, [Enabling Industrial Protocols](#)**, for information about enabling and switching communications protocols.
- CS50 Software jobs use di-soric Link functionality to accommodate PROFINET I/O communications between the camera and the PLC.
Important: PROFINET I/O allows the IP address and subnet mask of the camera to be assigned automatically by the PLC. In order to allow this, the CS50 Sensor may not have an assigned IP address on reboot until the PLC is set to Run mode. During this time, the CS50 Sensor will not be visible on the network for CS50 Software.

Overview

In this demonstration, you will learn how to load a saved job into the camera, establish connectivity via PROFINET I/O to a Siemens ET200SP CPU PLC, and run some example programs that interface with the camera. While evaluating PROFINET I/O capabilities, you will:

- **Begin with CS50 Software.**

Open a sample demo vision job in CS50 Software and use the Try Out feature to learn what to expect from the camera before it is connected to the PLC.

- **Prepare the PLC.**

Integrate the camera into the PLC environment with TIA Portal software and the GSD file.

- **Run the camera.**

Trigger the camera while it is online with the PLC and observe changes in the Inspection status as the PLC reconfigures the vision job's parameters. Prior to starting CS50 Software, make sure the camera is either connected to the PLC or both PLC and camera are on the same physical network. Ensure that the PC, PLC, and camera have the same network class and corresponding subnet addresses.

Open CS50 Software and select the camera.

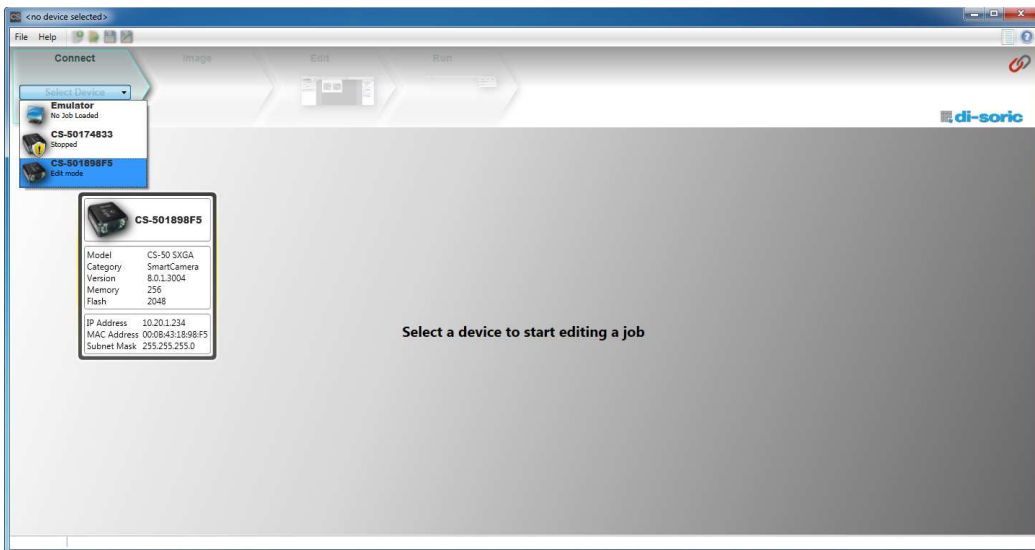

From the Image view, click the **Load a Job** button. Then navigate to **C:\di-soric\Vscape\Tutorials And Samples\CS50 Sensor\PROFINET demo\TIAPortal_Demos\BlobDemo**. Select **BlobDemo.avp**.

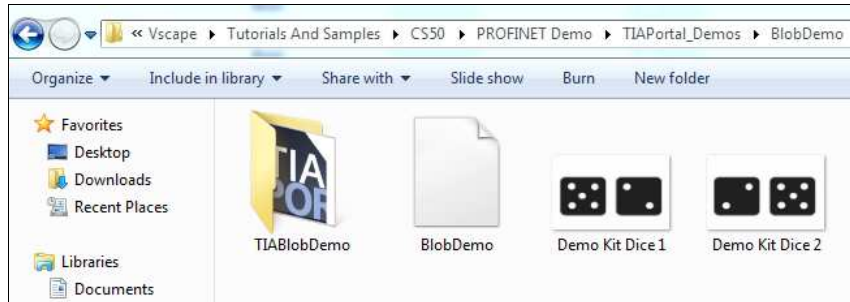

The demo job will include one tool: **Count Blobs**.



The Blob tool data item linked to the PROFINET I/O structure as shown here:

Tool Result	PLC IN
Number of parts	"UserData".NumberOfParts (%DB2.DBW0)

This data is transferred cyclically between the camera and PLC.

Once the job has loaded, the next step is to link the pre-saved images on the local PC. On the **Camera** button, click the far left icon to select and load an image.



A file browser will open. Then navigate to the same folder where the demo job was loaded PROFINET I/O Demo. If the images are located, the icon will change from a camera to a folder.



By clicking the **Try Job Once** icon, the application will cycle through the entire job with the loaded image.



There are two images on file. One will pass the inspection and one will fail.

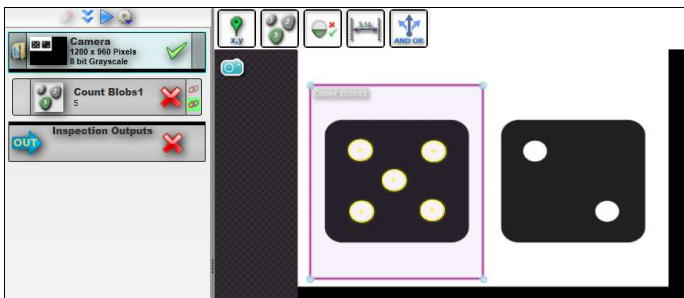
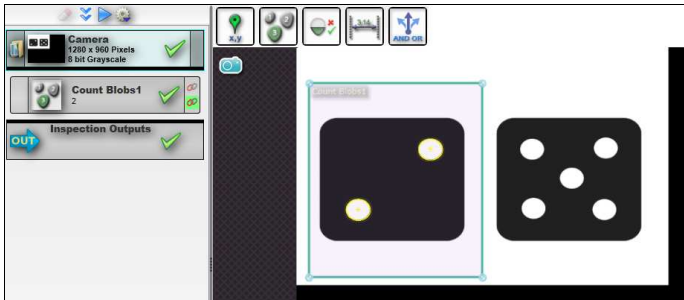

Now click the **Run** button on the top ribbon. This will download the job to the camera. At this point the job is ready to run and can be tested. However, in order to run the job change demo this job needs to be loaded into **Slot 1**. Click back to the **Edit** view from the top ribbon bar.

Click the slot icon and select Slot 1 or **New Slot** if no slots are currently in use.



Now the job and images will be saved to the flash memory of the camera.

TIA Portal V13 Setup

This section was created using Siemens TIA Portal software version 13 and an ET200SP CPU catalog number 6ES7 510-1DJ01-0AB0, HW version 2, FW version 1.8.2.

First launch the TIA Portal from the desktop.



Create a new project from the menu item **Project->New**. The default name is Project1 as seen below. Fill out the required information, then click **Create**.

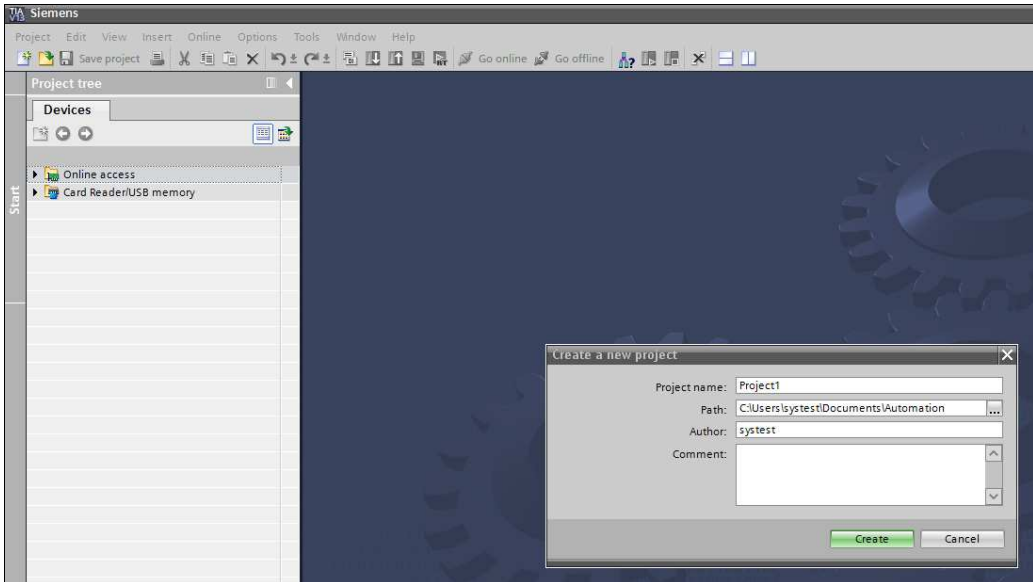

The screen below shows the main screen you will see when a project is opened.

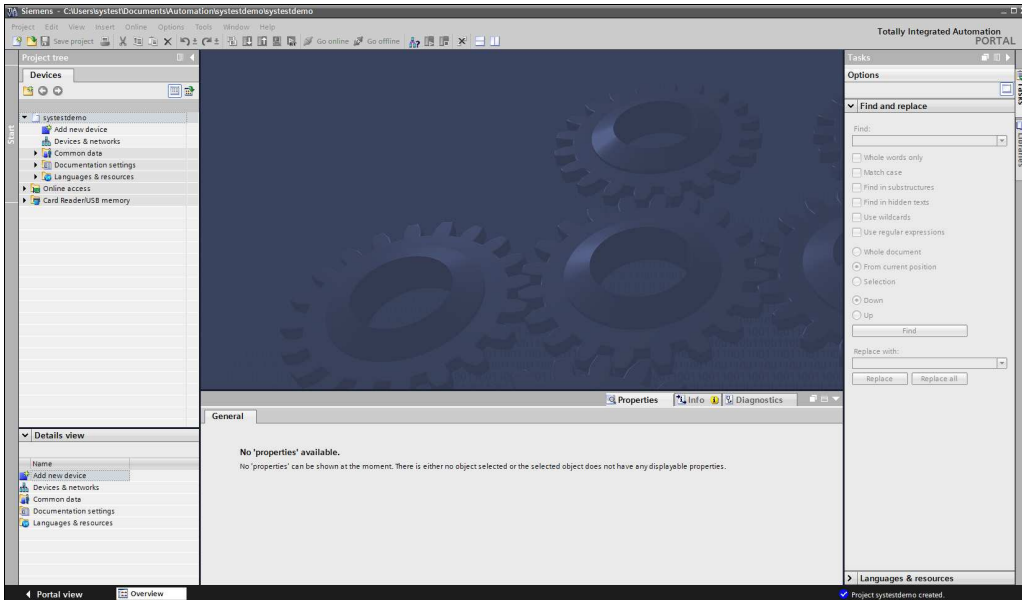

Double-click **Add new device**.

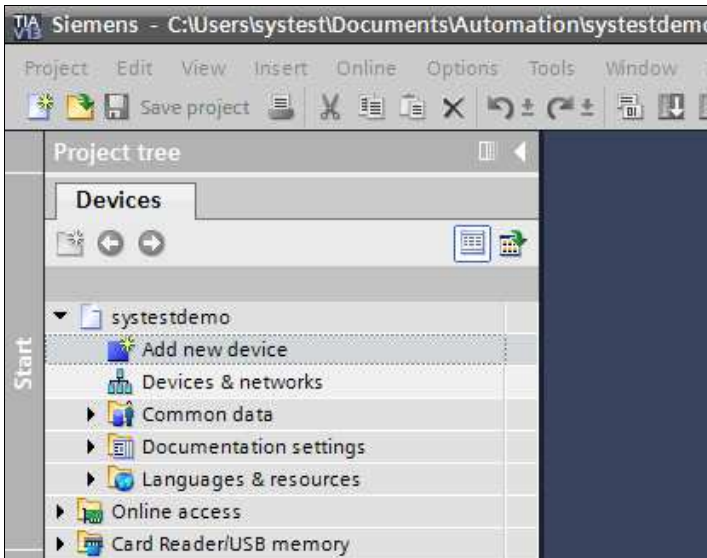

Open the **SIMATIC ET200 CPU** arrow, then open the **ET200SP CPU** arrow, then open the **CPU 1510SP-1 PN**, then click on **6ES7 510-1DJ01-0AB0**. You will see the screen below. Click **OK**.

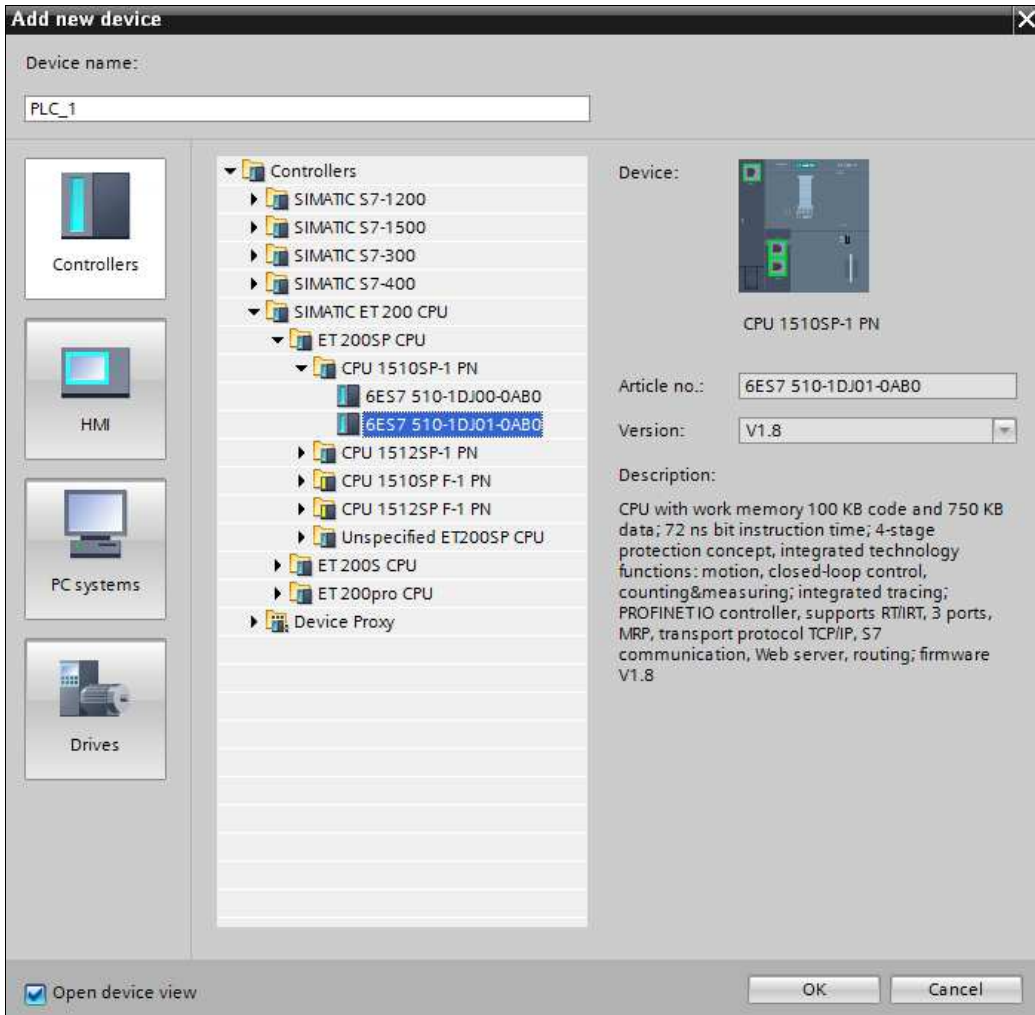

You will see the following screen.

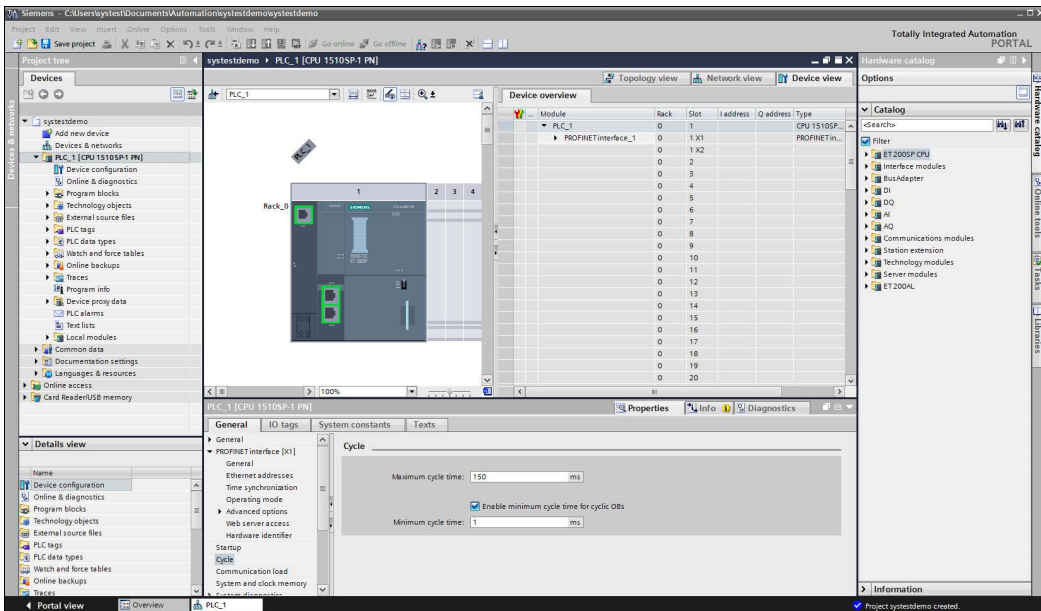

Click the lower green box on the PLC picture. The following will be displayed in the lower pane.

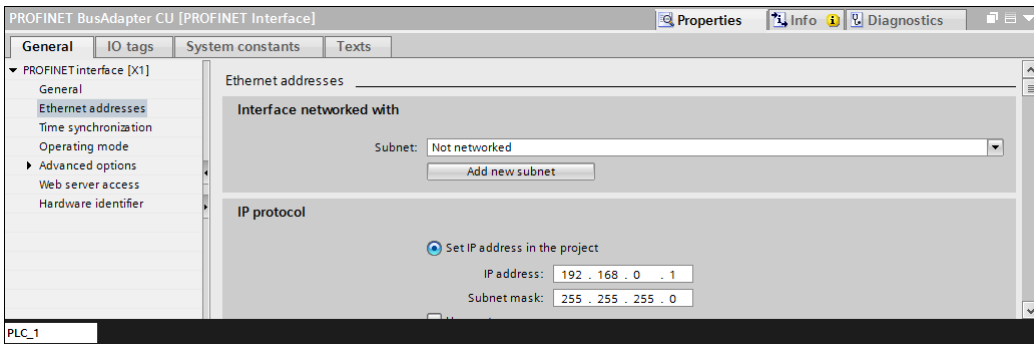

Click **Add new subnet**. The Subnet field will show PN/IE_1. Now go to the IP address field, and type the IP address you wish to use for this device. Click **Save Project** often to save your work.

To the right of the screen, you will see the following:

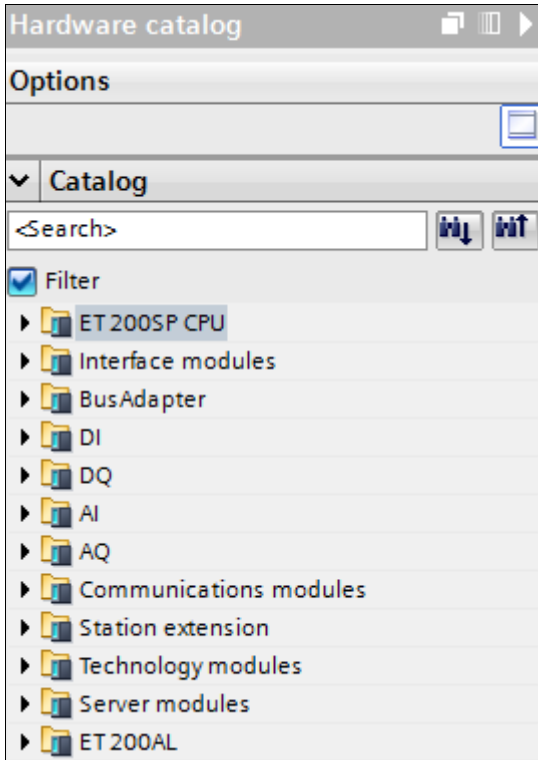

The modules in our test device are as follows:

1. DI 16x24VDC ST order number 6ES7 131-6BH00-0BA0
2. DQ 16x24VDC ST order number 6ES7 132-6BH00-0BA0

To add these modules, first click the arrow next to **DI**, keep clicking on arrows until you find the order number for device 1. Click and hold down the left mouse key. Drag it to slot 2 just to the left.

Your display should look like this:

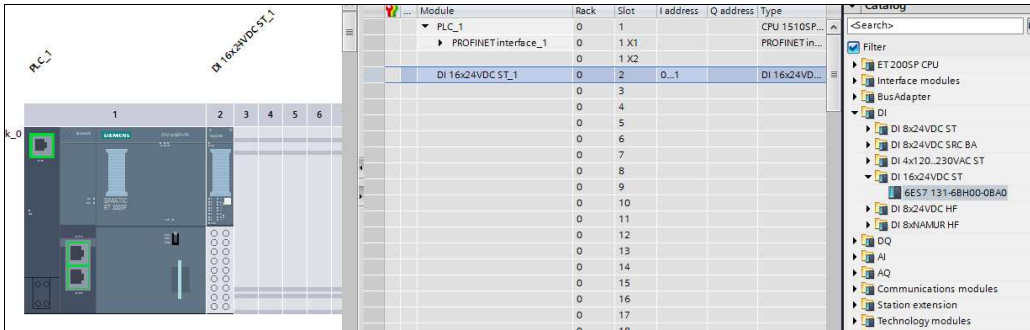

Do the same thing for device 2, looking under the **DQ** arrow. Your display should now look like this:

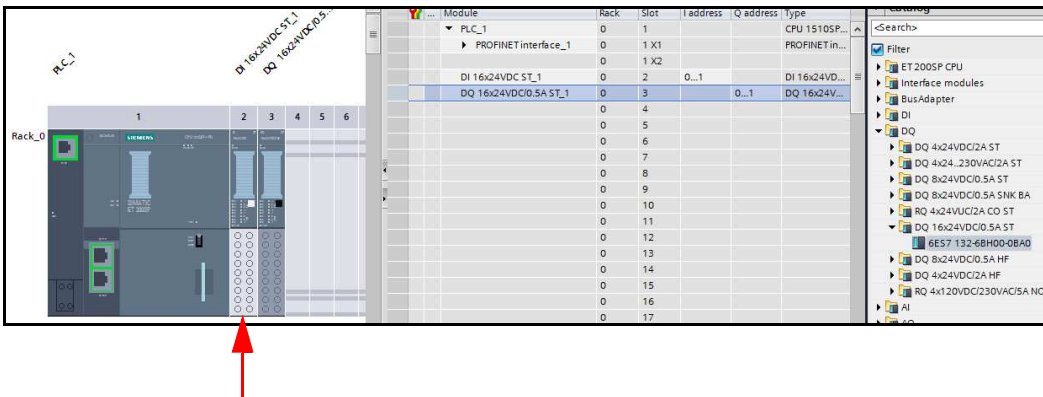

Now click on the PLC picture on slot 2. You will see the following screen:

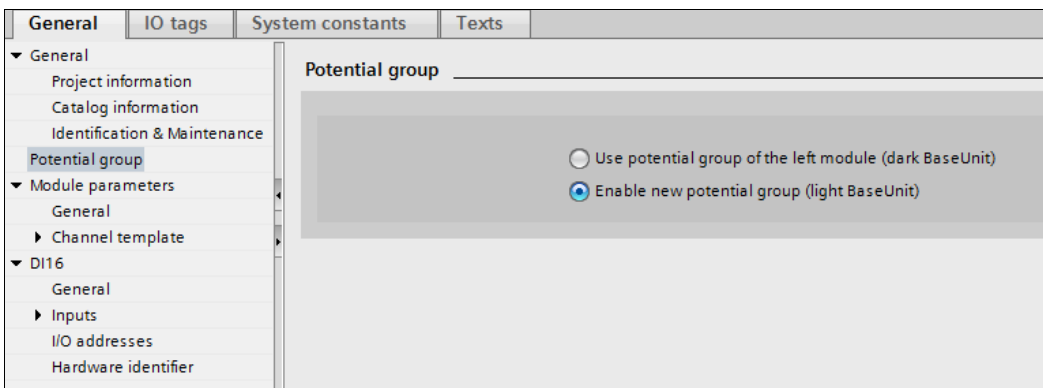

Be sure the **Enable new potential group (light Base Unit)** is selected. Do the same for Slot 3. Save the project.

Now click on **Options->Manage general station description files (GSD)**.

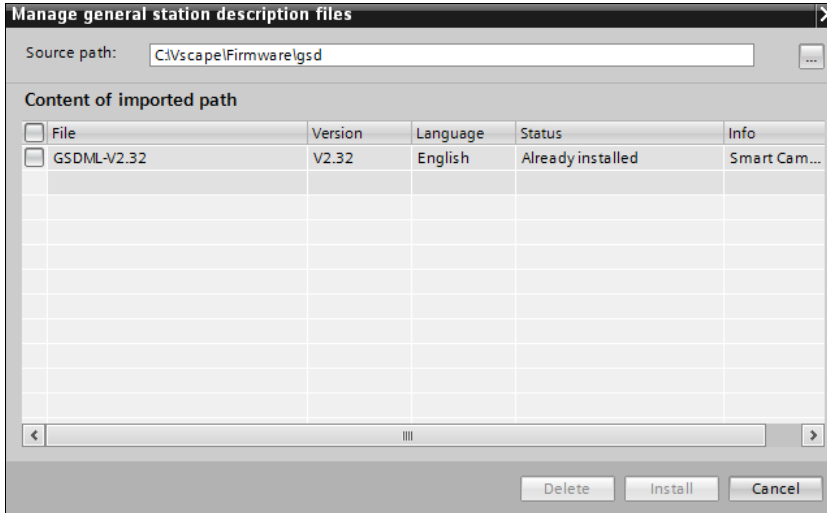

Browse to the following path: **C:\di-soric\VscapelFirmware\gsd\CS50 Sensor**. Select the appropriate GSD file by clicking the box next to the name, and click **Install**.

Click the tab that says **Network View**:

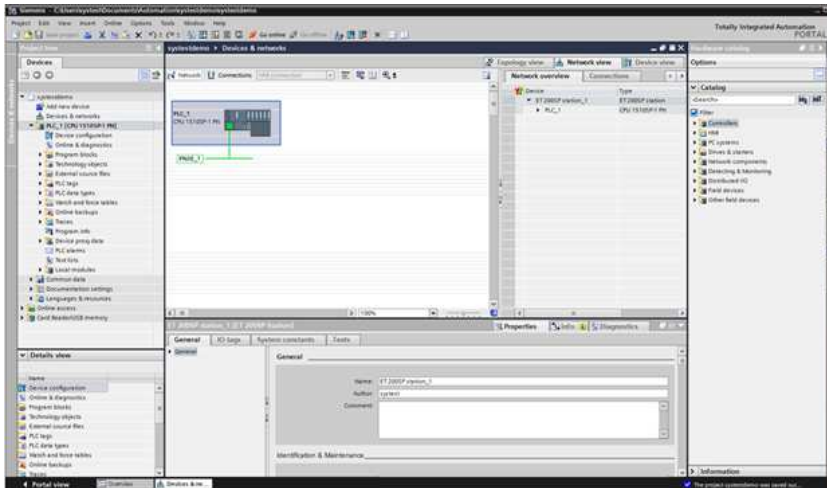

Look at the right panel and click **Hardware Catalog**. Use the arrows to open up the following area. **Other field devices->PROFINET IO ->General->di-soric->Smart Camera->CS50 Sensor**. Left-click on CS50 Sensor and hold it. Drag it to the left into the Devices and networks panel. Your screen will look like this:

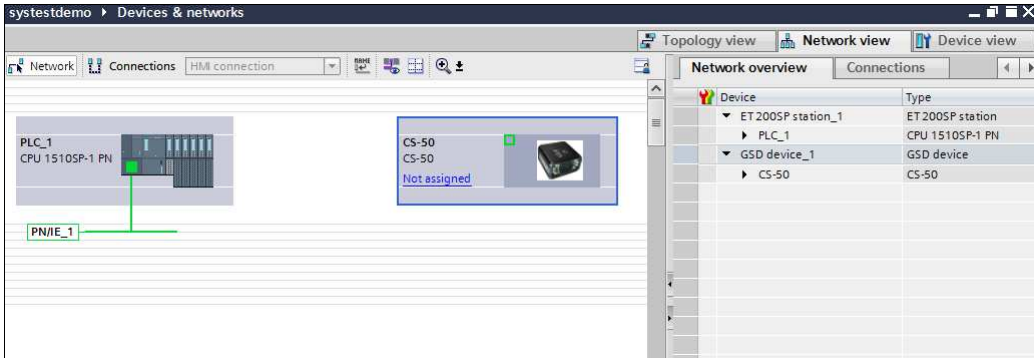

On the CS50 Sensor picture, click the **Not assigned** link, then click on **PLC_1.PROFINET IO-System**. This has just connected the CS50 Sensor to the PROFINET network.

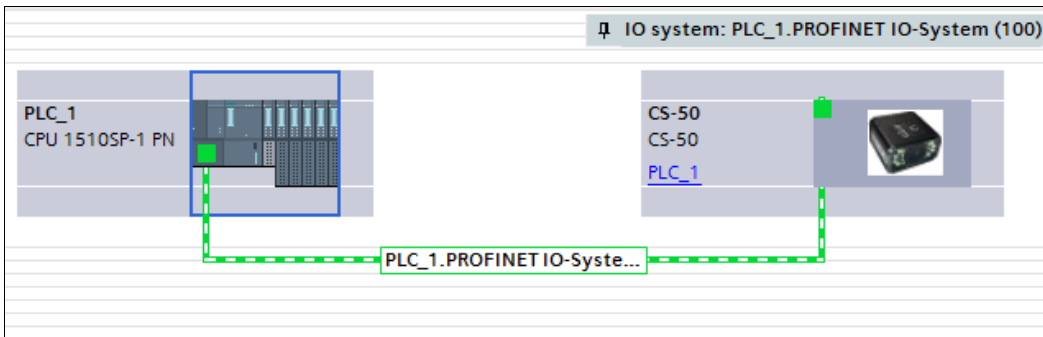

Double-click the picture of the CS50 Sensor. In the bottom pane you will see the following:

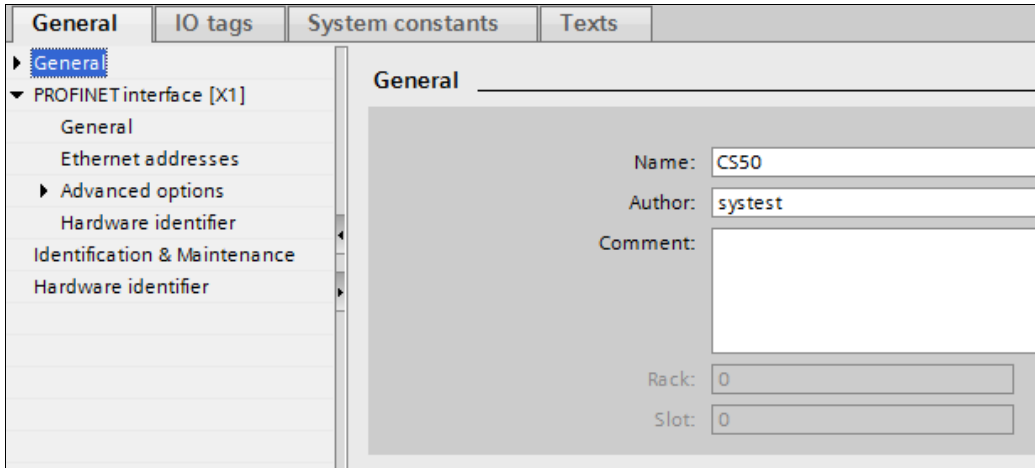

Enter the name of the device in the Name: field. Then click Ethernet addresses on the left, and type in the IP address of the camera. This will allow the PLC to set the camera IP.

Importing an Example Program

From TIA Portal, open the example program from the menu **Project > Open**. Click the **Browse** button to locate the (**BlobDemo.ap13**) program. The BlobDemo is located in **C:\di-soric\Vscape\Tutorials and Samples\CS50 Sensor\PROFINET Demo\TIAPortal_Demos\BlobDemo**. In the left pane in the **Devices** tab, open the PLC_1[CPU 1510SP-1 PN] arrow. Open the Program blocks arrow. Select all the blocks as shown below.

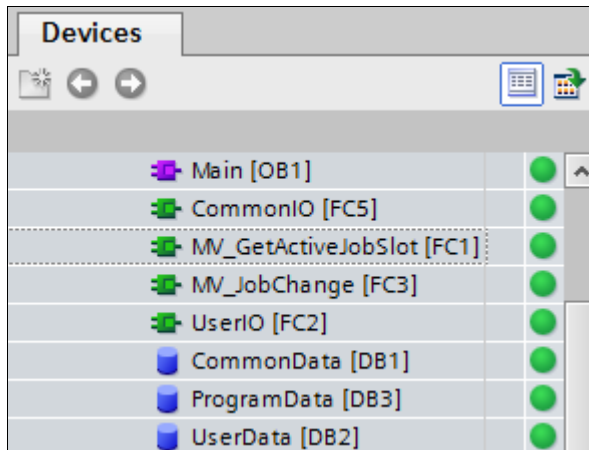

Right-click and copy. Go to your new project and open the same arrows, right-click on Program blocks, then click paste. Be sure to save your work. You may need to delete the Main [OB1] in the new project first.

Now back in the left pane of the BlobDemo project, click on PLC data types, right-click, copy, and paste them into the new project PLC data types.

In the left pane of the BlobDemo project, click on Watch and force tables. Right-click on Watch table_1, then copy. Paste into new project Watch and force tables. Be sure to save the project.

Your data in the new project should look like this:

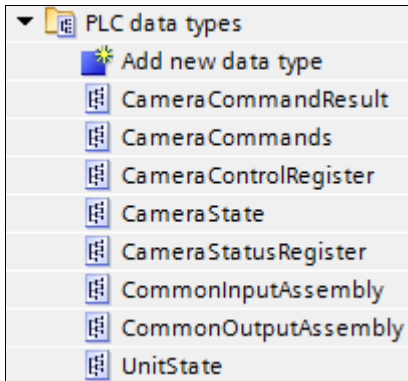

Checking the Mapping of IO

Depending on the order the PLC can load things, we may need to change the IO addresses in our block to match the Device Overview in the Device view screen.

Double-click on the CS50 Sensor picture, and the Device overview will be displayed to the right.

The image below is intended as an example only and may not exactly resemble your Device Overview.

Device overview						
...	Module	Rack	Slot	I address	Q address	Type
	▼ CS501898f5	0	0			CS50
	▶ Interface	0	0 X1			CS50
	Status_1	0	1	2...3		Status
	Control_1	0	2		2...3	Control
	Echo In_1	0	3	256...257		Echo In
	Echo Out_1	0	4		256...257	Echo Out
	Cmd Code Rslt_1	0	5	258...261		Cmd Code Rslt
	Cmd Code_1	0	6		258...261	Cmd Code
	Cmd Ret_1	0	7	262...265		Cmd Ret
	Cmd Arg_1	0	8		262...265	Cmd Arg
	State_1	0	9	266		State
		0	10			
		0	11			
		0	12			
		0	13			
		0	14			
		0	15			
		0	16			

From the Hardware catalog display to the far right, open the **Module** selection. You will see the following:

Module
Boolean In
Boolean Out
Float In
Float Out
Int In
Int Out
Long In
Long Out
Long String In
Long String Out
Short String In
Short String Out
VIO In
VIO Out

You must manually drag and drop “Int In” into the Device Overview pane. Click “Int In” and TIA will highlight the slot to drag it to. TIA will only allow you to insert them into their proper slot position.

Your device view should now look as follows. The example addresses shown will not be the same for your device.

Device overview							
		Module	Rack	Slot	I address	Q address	Type
		▼ CS501898f5	0	0			CS50
		▶ Interface	0	0 X1			CS50
		Status_1	0	1	2...3		Status
		Control_1	0	2		2...3	Control
		Echo In_1	0	3	256...257		Echo In
		Echo Out_1	0	4		256...257	Echo Out
		Cmd Code Rslt_1	0	5	258...261		Cmd Code Rslt
		Cmd Code_1	0	6		258...261	Cmd Code
		Cmd Ret_1	0	7	262...265		Cmd Ret
		Cmd Arg_1	0	8		262...265	Cmd Arg
		State_1	0	9	266		State
			0	10			
			0	11			
			0	12			
			0	13			
			0	14			
		Int In_1	0	15	4...23		Int In
			0	16			

You need to modify the PLC program blocks to agree with this display. On the left under the Devices pane, open the Program blocks arrow, and double-click on **OB1 [OB1]**. This will open a screen in the middle pane. Scroll this middle pane down until you see Network 1.

Change the numbers here to match with the Device overview display, as shown in the example below. Leave the DB_Number as is.

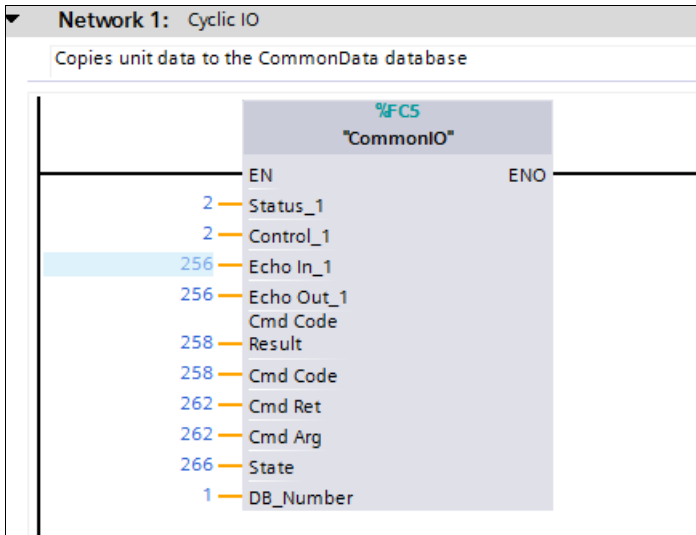

Repeat this for Network 4, using the Int In_1 address from the Device Overview and put it in the INT_ADDR below. Leave the DB_Number as is.

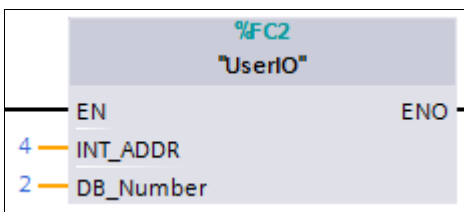

Be sure to save the project. Click the **PLC_1 {CPU 1510SP-1 PN}** top level, then click the compile icon.



There should be NO compile errors. If there are no errors, click the download icon.



You will see the following screen:

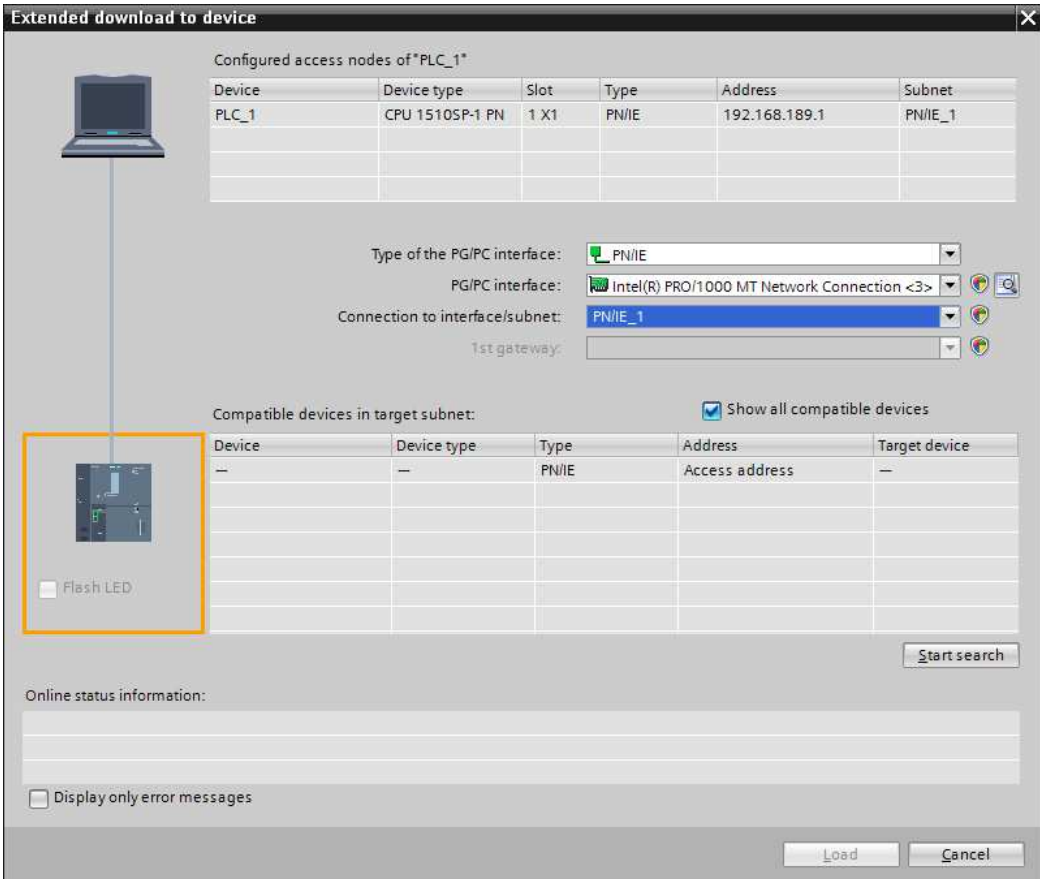

Select your PC network interface, and change the Connection to interface/subnet to **PN/IE_1**. Click **Start Search**. PLC_1 should be displayed with the address you gave it. Click **Load**. If you see a screen similar to below, do a memory reset (MRES) on the PLC, and try to load again. If this continues to be an issue, click **Continue without synchronization** and continue.

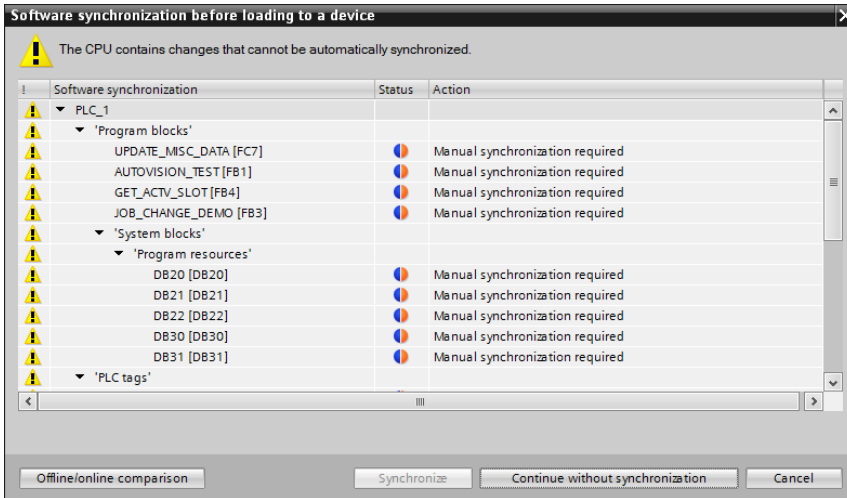

When downloading is working correctly you will see the following:

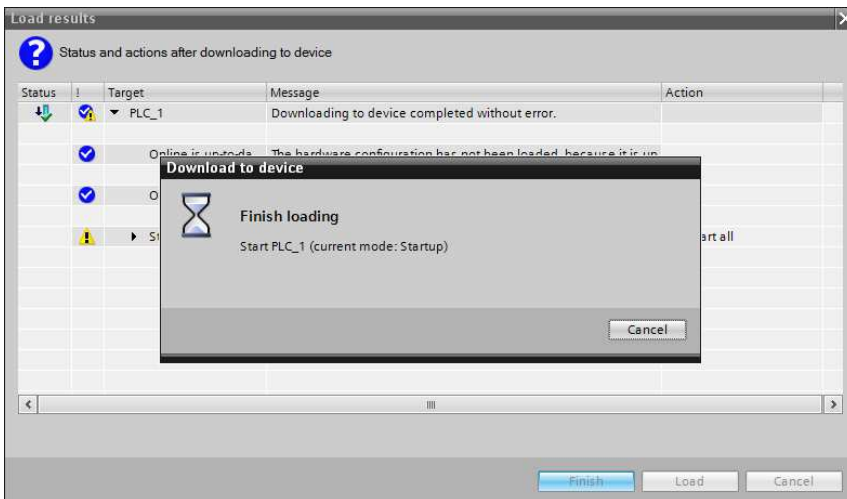

All LEDs on the PLC should be **GREEN**. Click **Go online**. You should see the following:

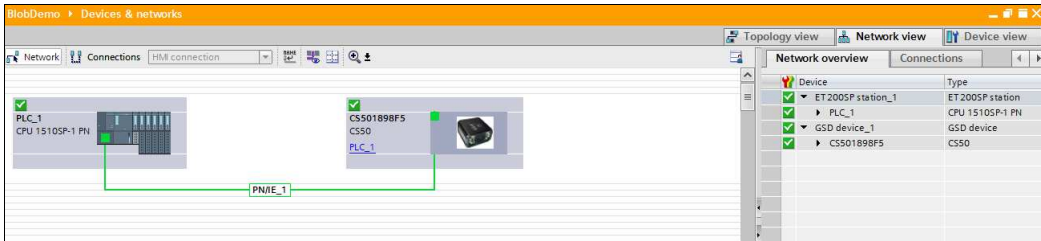

Troubleshooting

If all LEDs are not green, go offline and click the Accessible devices icon.



Click **Start search**. The PLC and the CS50 Sensor should be displayed here.

Accessible devices

Type of the PG/PC interface:

PG/PC interface:

Accessible nodes of the selected interface:

Device	Device type	Type	Address	MAC address
win-sn7tk0uevh9	SIMATIC-PC	PN/IE	192.168.20.175	00-05-1B-B0-2F-58
plc_1	CPU 1510SP-1 PN	PN/IE	192.168.189.1	28-63-36-48-AD-40
cs-501898f5	Smart Camera	PN/IE	192.168.189.4	00-0B-43-18-6C-49

Flash LED

Start search

Online status information:



- Retrieving device information...
- Scan and information retrieval completed.
- Display only error messages

Show Cancel

If the name of the CS50 Sensor is not correct, you will not connect. The default name is cs50 with the last 3 of the MAC address. Ex: cs50186c49. Go back to the general settings of the CS50 Sensor in the device view, and change the name if required. Re-compile, and re-load. Try running again. This is the most common reason for not connecting.

Running the Demo

In the left pane click the Watch and force tables arrow. Double-click Watch table_1. The watch table will open in the center pane. Click on the monitor variables icon.

i	Name	Address	Display format	Monitor v...	Modify value	
1	*ProgramData*.ChangeJob		Bool	<input type="checkbox"/> FALSE		<input type="checkbox"/>
2	*ProgramData*.New_JobSlot		DEC+/-	2		<input type="checkbox"/>
3	*ProgramData*.Get_CurrentJobSlot		Bool	<input type="checkbox"/> FALSE		<input type="checkbox"/>
4	*ProgramData*.Current_JobSlot		DEC+/-	1		<input type="checkbox"/>
5	*ProgramData*.Trigger 		Bool	<input type="checkbox"/> FALSE		<input type="checkbox"/>
6	*ProgramData*.TotalTriggerCount		DEC+/-	1		<input type="checkbox"/>
7	*ProgramData*.Pass		Bool	<input type="checkbox"/> FALSE		<input type="checkbox"/>
8	*ProgramData*.TotalPassedCount		DEC+/-	0		<input type="checkbox"/>
9	*ProgramData*.Fail		Bool	<input checked="" type="checkbox"/> TRUE		<input type="checkbox"/>
10	*ProgramData*.TotalFailedCount		DEC+/-	1		<input type="checkbox"/>
11	*ProgramData*.TotalInspCount		DEC+/-	1		<input type="checkbox"/>
12	*ProgramData*.ResetCounters		Bool	<input type="checkbox"/> FALSE		<input type="checkbox"/>
13	*UserData*.NumberOfParts	%DB2.DBWO	Hex	16#0000		<input type="checkbox"/>
14	*ProgramData*.ResetError		Bool	<input type="checkbox"/> FALSE		<input type="checkbox"/>
15	*ProgramData*.CommandResult.Fail		Bool	<input type="checkbox"/> FALSE		<input type="checkbox"/>
16	*ProgramData*.CommandResult."No Job In Slot"		Bool	<input type="checkbox"/> FALSE		<input type="checkbox"/>
17	*ProgramData*.CommandResult.UnknownCmd		Bool	<input type="checkbox"/> FALSE		<input type="checkbox"/>
18	*ProgramData*.CommandResult.Success		Bool	<input type="checkbox"/> FALSE		<input type="checkbox"/>

The following operations can be tried here:

Change Job	Switch jobs from one slot to another
Get Current Job Slot	Displays the slot of the currently running job
Trigger an Inspection	Causes the camera to cycle through its inspection.
Reset Counters	Resets the TotalTriggerCount, TotalPassedCount, TotalFailedCount, and TotalInspCount to 0, and also sends a command to the camera to reset its internal counters.
Reset an Error condition	If an error occurs during run time, this will reset it, so demo may be continued.

Change Jobs + Get Current Job Slot

Be sure to store a job in a slot in the camera memory as described earlier. To execute this test properly, load another job into **Slot 2** of the camera. For example, the **Circle_LocatorDemo** job. CS50 Software must be closed to run this demo.

Go to **Watch table_1**, and click the button with the glasses and “play” symbol. This begins the monitoring of data.

	Name	Address	Display format	Monitor value	Modify value	
1	*ProgramData*.ChangeJob		Bool	<input type="checkbox"/> FALSE		<input type="checkbox"/>
2	*ProgramData*.New_JobSlot		DEC+/-	1		<input type="checkbox"/>
3	*ProgramData*.Get_CurrentJobSlot		Bool	<input type="checkbox"/> FALSE		<input type="checkbox"/>
4	*ProgramData*.Current_JobSlot		DEC+/-	2		<input type="checkbox"/>
5	*ProgramData*.Trigger		Bool	<input type="checkbox"/> FALSE		<input type="checkbox"/>
6	*ProgramData*.TotalTriggerCount		DEC+/-	7		<input type="checkbox"/>
7	*ProgramData*.Pass		Bool	<input type="checkbox"/> FALSE		<input type="checkbox"/>
8	*ProgramData*.TotalPassedCount		DEC+/-	4		<input type="checkbox"/>
9	*ProgramData*.Fail		Bool	<input checked="" type="checkbox"/> TRUE		<input type="checkbox"/>
10	*ProgramData*.TotalFailedCount		DEC+/-	3		<input type="checkbox"/>
11	*ProgramData*.TotalInspCount		DEC+/-	7		<input type="checkbox"/>
12	*ProgramData*.ResetCounters		Bool	<input type="checkbox"/> FALSE		<input type="checkbox"/>
13	*UserData*.NumberOfParts	%DB2.DBW0	Hex	16#0000		<input type="checkbox"/>
14	*ProgramData*.ResetError		Bool	<input type="checkbox"/> FALSE		<input type="checkbox"/>
15	*ProgramData*.CommandResult.Fail		Bool	<input type="checkbox"/> FALSE		<input type="checkbox"/>
16	*ProgramData*.CommandResult.No Job In Slot*		Bool	<input type="checkbox"/> FALSE		<input type="checkbox"/>
17	*ProgramData*.CommandResult.UnknownCmd		Bool	<input type="checkbox"/> FALSE		<input type="checkbox"/>
18	*ProgramData*.CommandResult.Success		Bool	<input type="checkbox"/> FALSE		<input type="checkbox"/>
19	<Add new>					

Using the Watch table_1 elements **ChangeJob** and **New_JobSlot**, click on the **Modify Value** column next to **New_JobSlot**, type 2, type **Enter**. Click on the Modify value to the right of ChangeJob and enter **TRUE**. Click on the lightning bolt with a **1** at the top. This will set the job slot to 2. Then click the lightning bolt button again.

	Name	Address	Display format	Monitor value	Modify value		Comment
1	*ProgramData*.ChangeJob		Bool	<input type="checkbox"/> FALSE	TRUE	<input checked="" type="checkbox"/>	
2	*ProgramData*.New_JobSlot		DEC+/-	1	2	<input checked="" type="checkbox"/>	
3	*ProgramData*.Get_CurrentJobSlot		Bool	<input type="checkbox"/> FALSE		<input type="checkbox"/>	
4	*ProgramData*.Current_JobSlot		DEC+/-	2		<input type="checkbox"/>	
5	*ProgramData*.Trigger		Bool	<input type="checkbox"/> FALSE		<input type="checkbox"/>	
6	*ProgramData*.TotalTriggerCount		DEC+/-	0		<input type="checkbox"/>	
7	*ProgramData*.Pass		Bool	<input type="checkbox"/> FALSE		<input type="checkbox"/>	

The current job will be changed to the job in slot 2. To verify that this clears all changes made to the Modify value column, click on Modify value to the right of **Get_CurrentJobSlot**. Enter **TRUE**, and click on the lightning bolt button again.

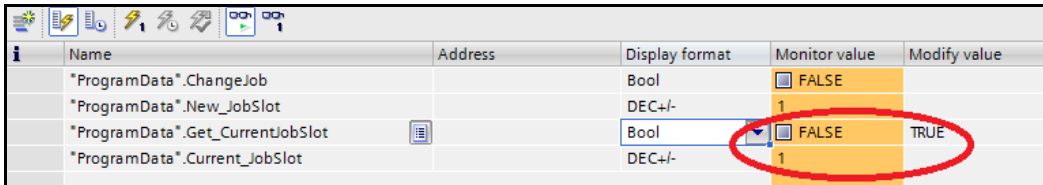

Name	Address	Display format	Monitor value	Modify value
ProgramData.ChangeJob		Bool	<input type="checkbox"/> FALSE	
ProgramData.New_JobSlot		DEC+/-	1	
ProgramData.Get_CurrentJobSlot		Bool	<input type="checkbox"/> FALSE	TRUE
ProgramData.Current_JobSlot		DEC+/-	1	

You will see the current job listed to the right of **Current_JobSlot**. You can repeat this procedure changing the slot back to 1 and verify that the current job slot is now **1**.

Trigger an Inspection and Reset Counters

Clear any changes made to the Modify value column. If you want to watch the inspection, be sure CS50 Software is running and connected to the device. Be sure the job is running. If you choose not to run CS50 Software, you can look at the LEDs on the device to confirm your triggers. Change the value to the right of **Trigger** to be **TRUE**, and click the lightning bolt button again.

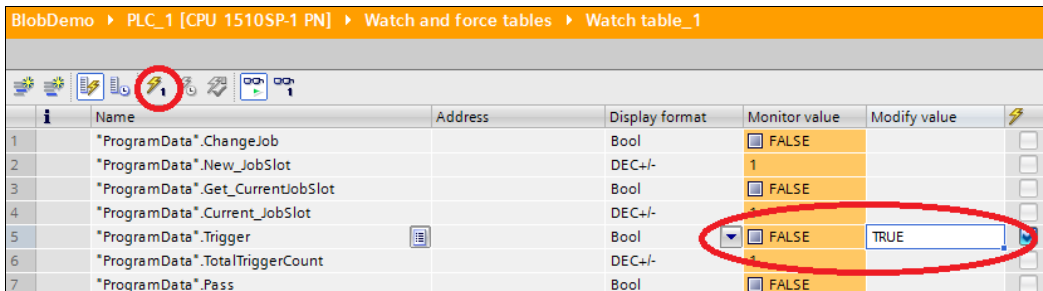

BlobDemo > PLC_1 [CPU 1510SP-1 PN] > Watch and force tables > Watch table_1

Name	Address	Display format	Monitor value	Modify value
ProgramData.ChangeJob		Bool	<input type="checkbox"/> FALSE	
ProgramData.New_JobSlot		DEC+/-	1	
ProgramData.Get_CurrentJobSlot		Bool	<input type="checkbox"/> FALSE	
ProgramData.Current_JobSlot		DEC+/-	1	
ProgramData.Trigger		Bool	<input type="checkbox"/> FALSE	TRUE
ProgramData.TotalTriggerCount		DEC+/-	1	
ProgramData.Pass		Bool	<input type="checkbox"/> FALSE	

You will see the **NumberOfParts** change to either **2** or **5**. The pass and fail bools will indicate whether the inspection has passed or failed. Also, the appropriate counters will have incremented. Each click of the lightning bolt button will cause an inspection, which will bounce from one image to the next. One will pass and the next will fail.

To reset the counters, clear all settings in the Modify value column, and change the one next to **ResetCounters** to **TRUE**, and click the lightning bolt button again. You will see all the counters in blue reset to **0**.

	Name	Address	Display format	Monitor value	Modify value	
1	*ProgramData*.ChangeJob		Bool	<input type="checkbox"/> FALSE		
2	*ProgramData*.New_JobSlot		DEC+/-	1		
3	*ProgramData*.Get_CurrentJobSlot		Bool	<input type="checkbox"/> FALSE		
4	*ProgramData*.Current_JobSlot		DEC+/-	1		
5	*ProgramData*.Trigger		Bool	<input type="checkbox"/> FALSE		
6	*ProgramData*.TotalTriggerCount		DEC+/-	0		
7	*ProgramData*.Pass		Bool	<input checked="" type="checkbox"/> TRUE		
8	*ProgramData*.TotalPassedCount		DEC+/-	0		
9	*ProgramData*.Fail		Bool	<input type="checkbox"/> FALSE		
10	*ProgramData*.TotalFailedCount		DEC+/-	0		
11	*ProgramData*.TotalInspCount		DEC+/-	0		
12	*ProgramData*.ResetCounters		Bool	<input type="checkbox"/> FALSE	TRUE	
13	*UserData*.NumberOfParts	%DB2.DBW0	Hex	16#0002		
14	*ProgramData*.ResetError		Bool	<input type="checkbox"/> FALSE		

If you clear this again, set the Trigger to TRUE, and click the lightning bolt button again, you will notice that the counts start at 1 on both the PLC counters and CS50 Software counters.

Reset Error

If at any time there is an error indicated by a TRUE in any of the values below, you can clear the error by entering a TRUE to the right of **ResetError** and clicking the lightning button. Reset it to **FALSE** and click the button again. Any errors in the values below should be cleared.

ProgramData.CommandResult.Fail	Bool	<input type="checkbox"/> FALSE
ProgramData.CommandResult.*No Job In Slot*	Bool	<input type="checkbox"/> FALSE
ProgramData.CommandResult.UnknownCmd	Bool	<input type="checkbox"/> FALSE
ProgramData.CommandResult.Success	Bool	<input type="checkbox"/> FALSE

PROFINET I/O Circle Locate Demo Using TIA Portal V13 and CS50 Sensor

This section describes how to use di-soric demo PLC code with a vision job and camera target. The PROFINET I/O demo files can be found where CS50 Software is installed, in the folder: **C:\di-soric\Tutorials and Samples\CS50 Sensor\PROFINET demo\ TIAPortal_Demos\Circle_LocateDemo**. Open **Circle_LocatorDemo.avp** with CS50 Software and download it to the camera.

Notes:

- The camera communications protocol must be enabled for PROFINET I/O before it can be used in this environment. Refer to **Chapter 1, [Enabling Industrial Protocols](#)**, for information about enabling and switching communications protocols.
- CS50 Software jobs use di-soric Link functionality to accommodate PROFINET I/O communications between the camera and the PLC.

Important: PROFINET I/O allows the IP address and subnet mask of the camera to be assigned automatically by the PLC. In order to allow this, the CS50 Sensor may not have an assigned IP address on reboot until the PLC is set to Run mode. During this time, the CS50 Sensor will not be visible on the network for CS50 Software.

Overview

In this demonstration, you will learn how to load a saved job into the camera, establish connectivity via PROFINET I/O to a Siemens ET200SP CPU PLC, and run some example programs that interface with the camera. While evaluating PROFINET I/O capabilities, you will:

- **Begin with CS50 Software.**

Open a sample demo vision job in CS50 Software and use the Try Out feature to learn what to expect from the camera before it is connected to the PLC.

- **Prepare the PLC.**

Integrate the camera into the PLC environment with TIA Portal software and the GSD file.

- **Run the camera.**

Trigger the camera while it is online with the PLC and observe changes in the Inspection status as the PLC reconfigures the vision job's parameters. Prior to starting CS50 Software, make sure the camera is either connected to the PLC or both PLC and camera are on the same physical network. Ensure that the PC, PLC, and camera have the same network class and corresponding subnet addresses.

Open CS50 Software and select the camera.

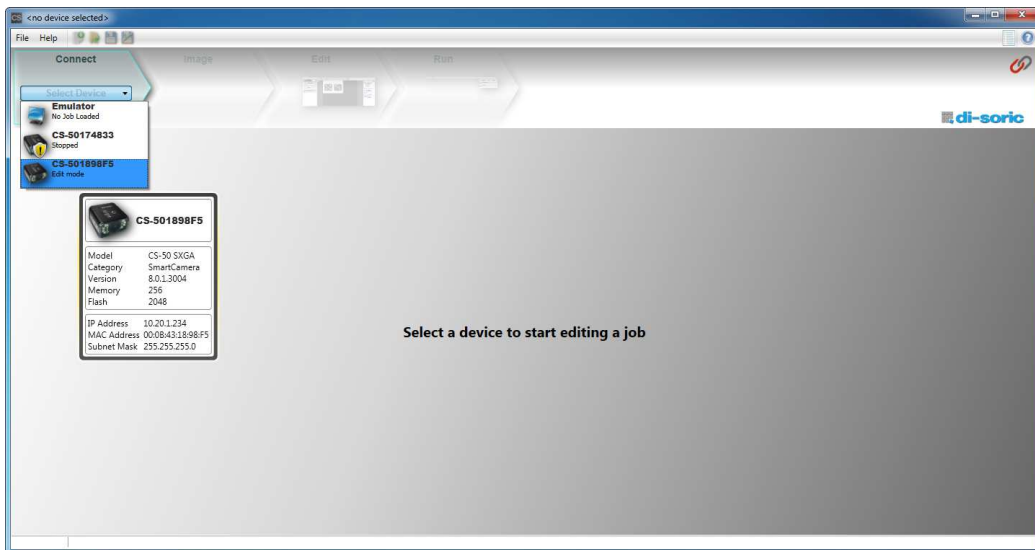

From the Image view, click the **Load a Job** button. Then navigate to **C:\di-soric\Vscape\Tutorials And Samples\CS50 Sensor\PROFINET demo\TIAPortal_Demos\Circle_LocatorDemo**. Select **Circle_LocatorDemo.avp**.

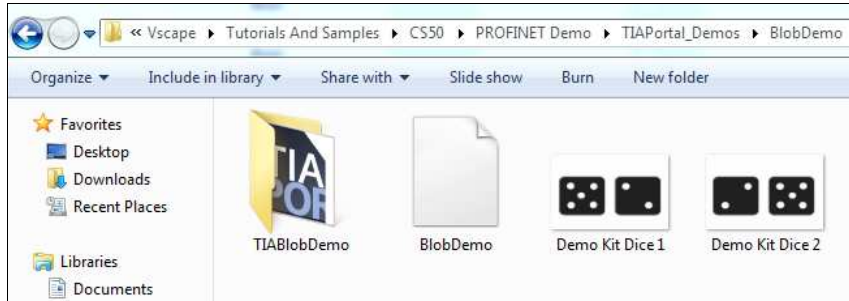

The demo job will include two tools: **Locate Shape** and **Circle**.



The PROFINET I/O structure is shown here:

Tool Result	PLC IN
Instance Point1	"UserData".Instance1Point1(%DB2.DBD2)
Instance Point2	"UserData".Instance1Point2(%DB2.DBD6)
Instance Point3	"UserData".InstancePoint3(%DB2.DBD10)
Status	"UserData".Status[0](%DB2.DBX0.0)
RadiumDatum	"UserData".RadiusDatum(%DB2.DBD14)

This data is transferred cyclically between the camera and PLC.

Once the job has loaded, the next step is to link the pre-saved images on the local PC. On the **Camera** button, click the far left icon to select and load an image.



A file browser will open. Then navigate to the same folder where the demo job was loaded PROFINET I/O Demo. If the images are located, the icon will change from a camera to a folder.

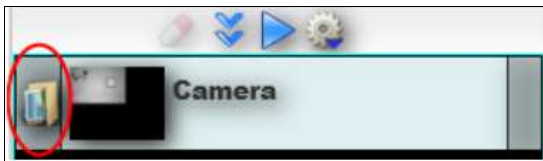

By clicking the **Try Job Once** icon, the application will cycle through the entire job with the loaded image.

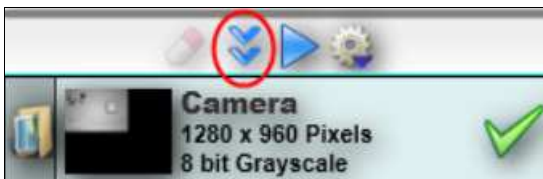

There are two images on file. One will pass the inspection and one will fail.

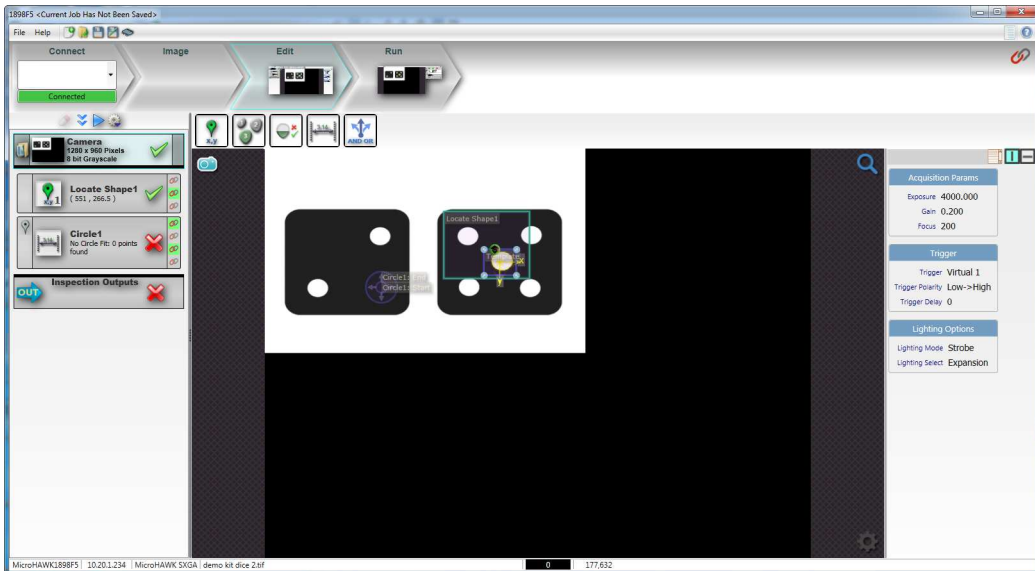
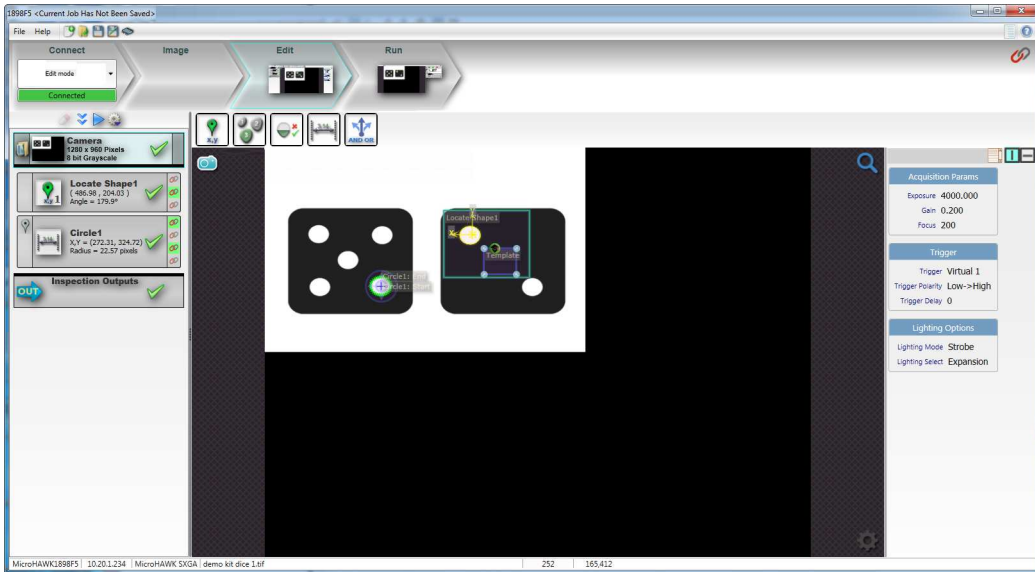

Now click the **Run** button on the top ribbon. This will download the job to the camera. At this point the job is ready to run and can be tested. However, in order to run the job change demo this job needs to be loaded into **Slot 1**. Click back to the **Edit** view from the top ribbon bar.

Click the slot icon and select Slot 1 or **New Slot** if no slots are currently in use.



Now the job and images will be saved to the flash memory of the camera.

TIA Portal V13 Setup

This section was created using Siemens TIA Portal software version 13 and an ET200SP CPU catalog number 6ES7 510-1DJ01-0AB0, HW version 2, FW version 1.8.2. This example shows the CS50 Sensor device. However, the steps are similar for any device.

First launch the TIA Portal from the desktop.



Create a new project from the menu item **Project->New**. The default name is Project1 as seen below. Fill out the required information, then click **Create**.

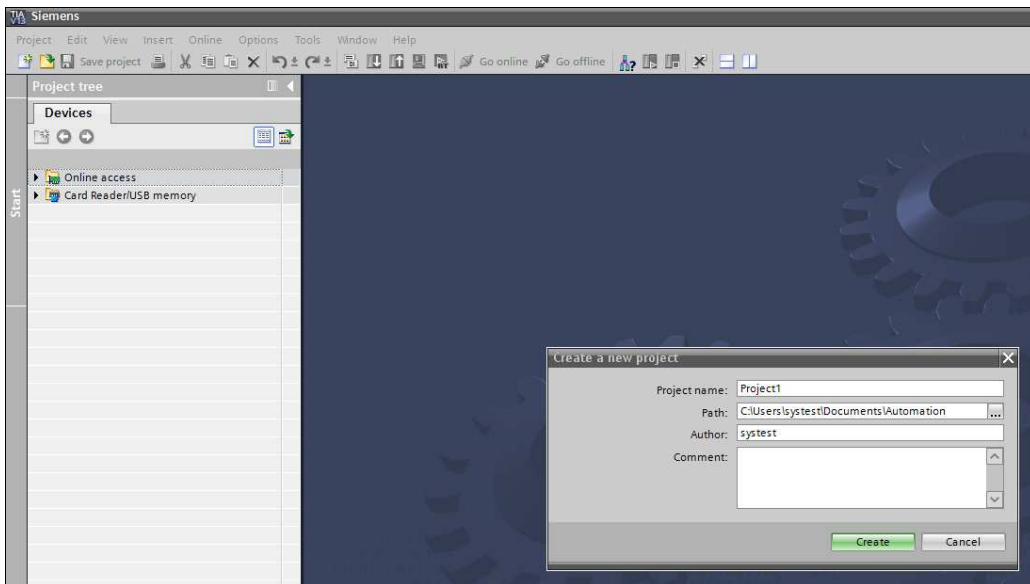

The screen below shows the main screen you will see when a project is opened.

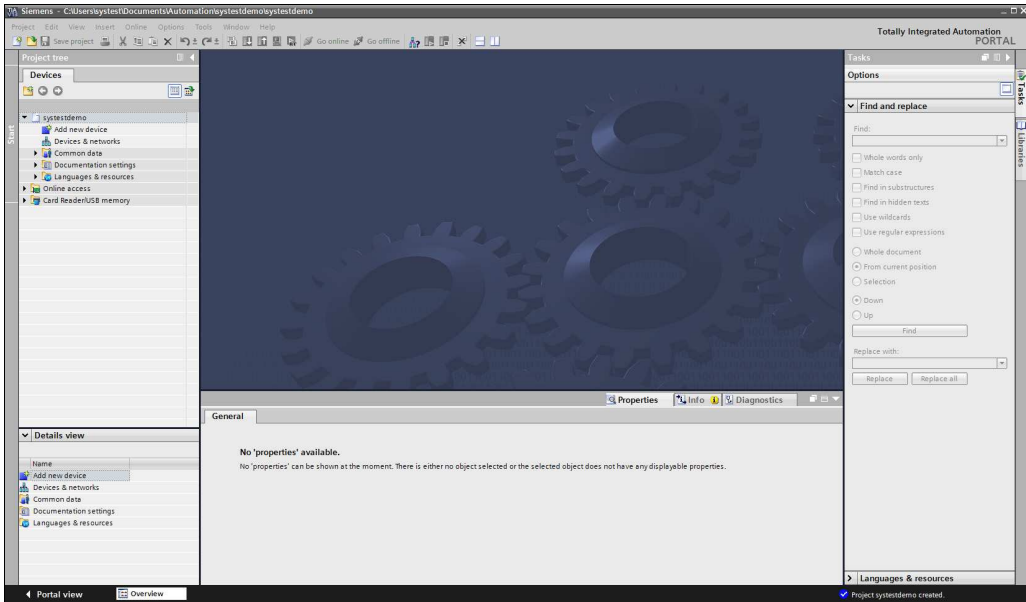

Double-click **Add new device**.

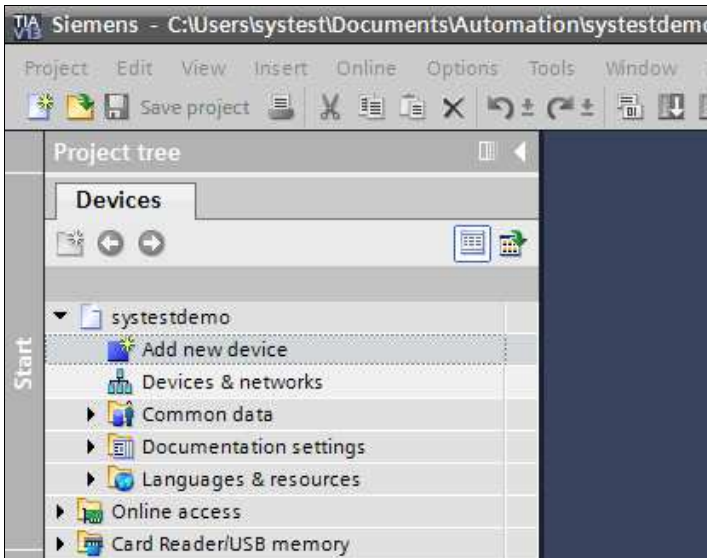

Open the **SIMATIC ET200 CPU** arrow, then open the **ET200SP CPU** arrow, then open the **CPU 1510SP-1 PN**, then click on **6ES7 510-1DJ01-0AB0**. You will see the screen below. Click **OK**.

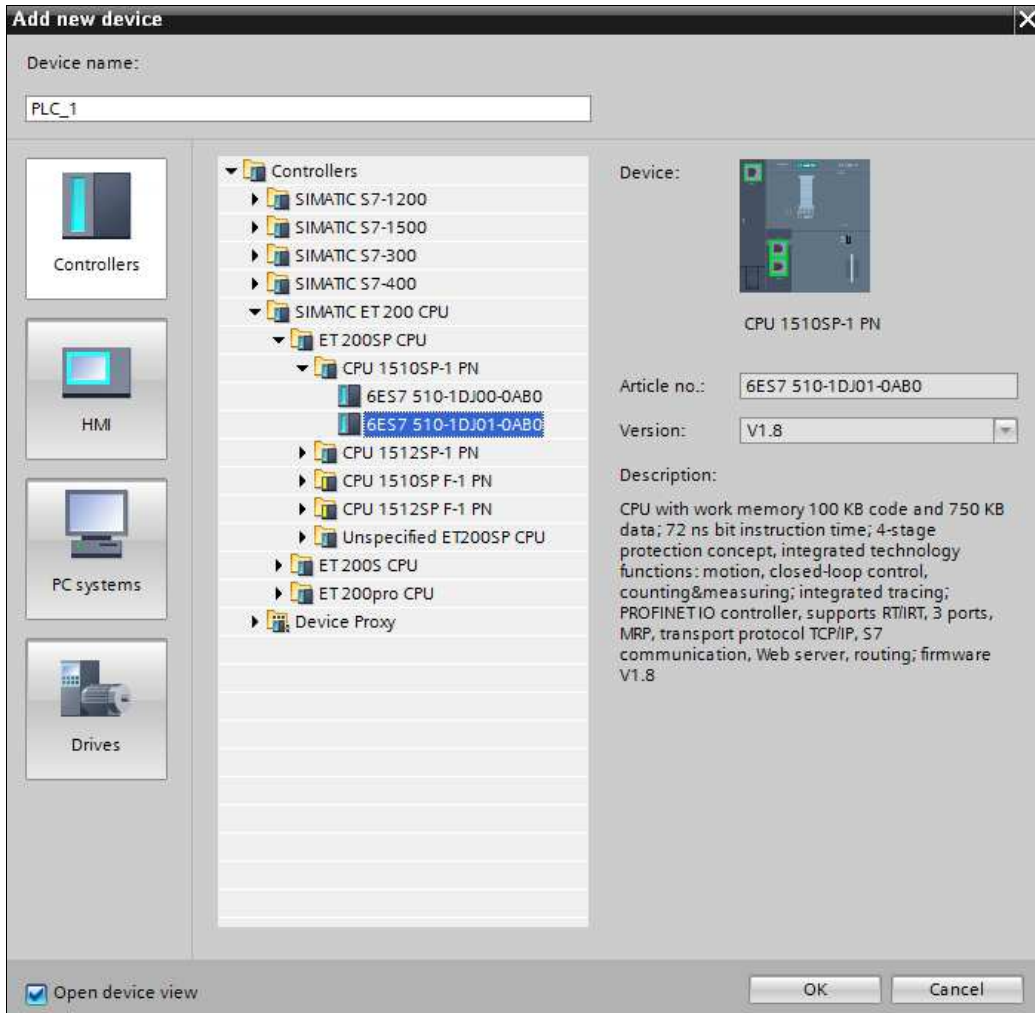

You will see the following screen.

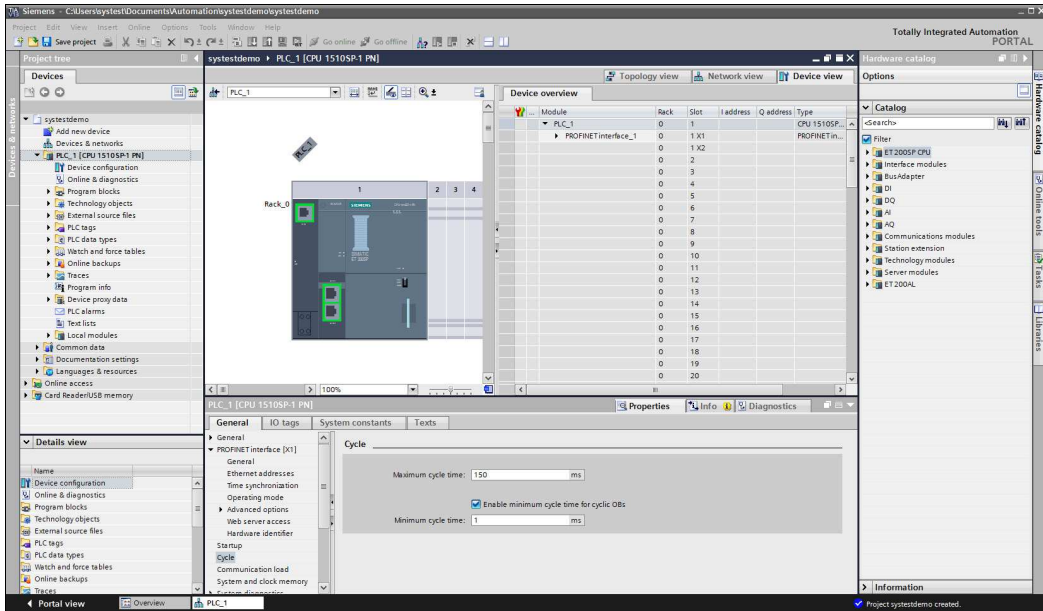

Click the lower green box on the PLC picture. The following will be displayed in the lower pane.

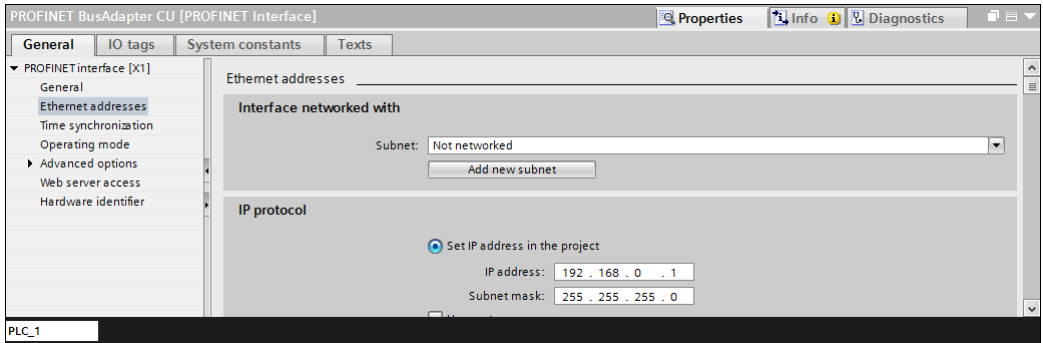

Click **Add new subnet**. The Subnet field will show PN/IE_1. Now go to the IP address field, and type the IP address you wish to use for this device. Click **Save Project** often to save your work.

To the right of the screen, you will see the following:

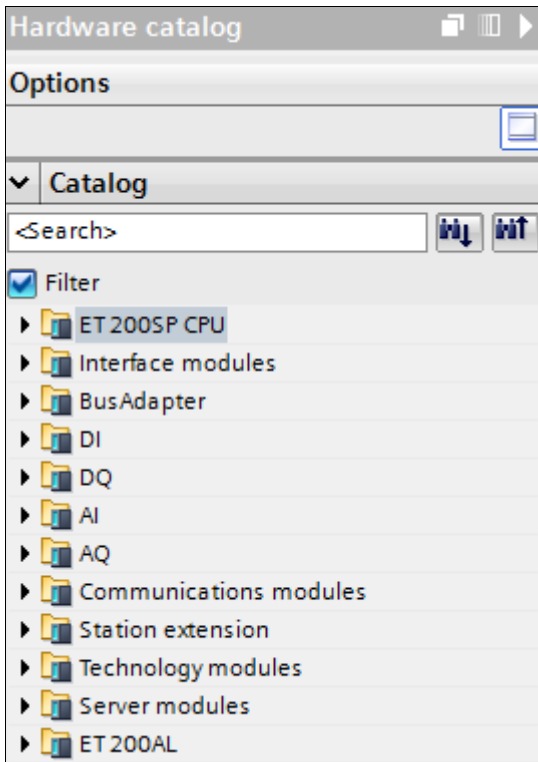

The modules in our test device are as follows:

1. DI 16x24VDC ST order number 6ES7 131-6BH00-0BA0
2. DQ 16x24VDC ST order number 6ES7 132-6BH00-0BA0

To add these modules, first click the arrow next to **DI**, keep clicking on arrows until you find the order number for device 1. Click and hold down the left mouse key. Drag it to slot 2 just to the left.

Your display should look like this:

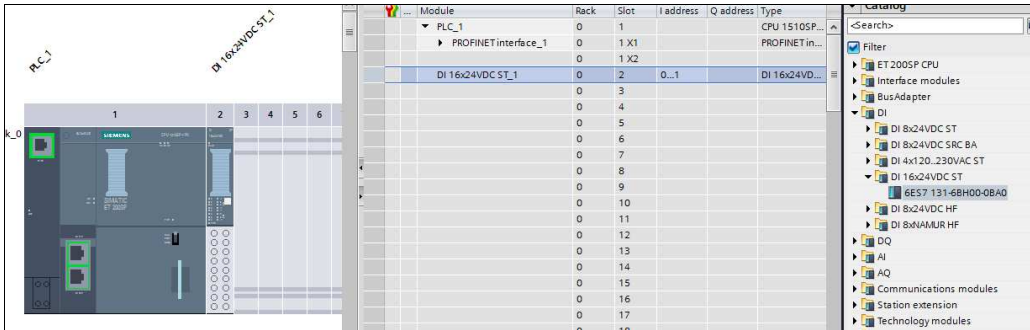

Do the same thing for device 2, looking under the **DQ** arrow. Your display should now look like this:

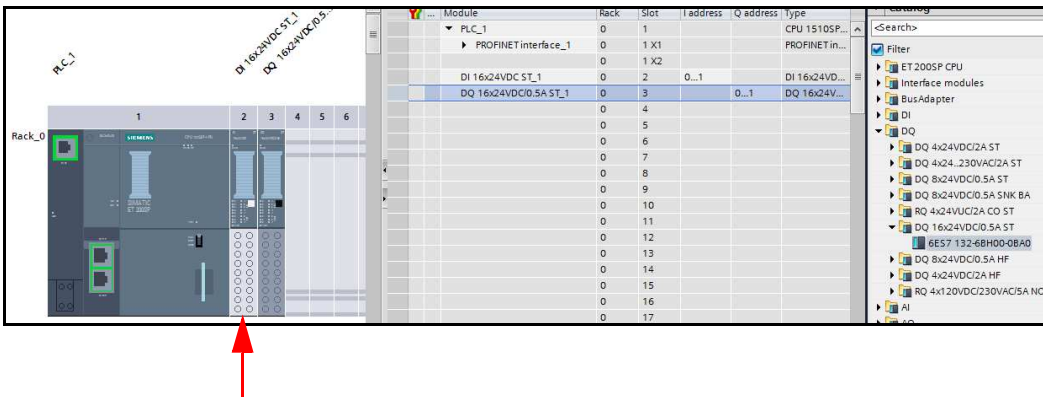

Now click on the PLC picture on slot 2. You will see the following screen:

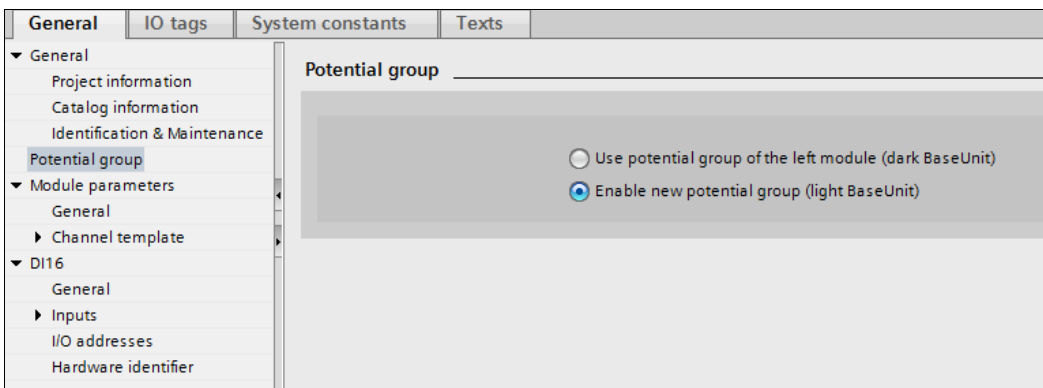

Be sure the **Enable new potential group (light Base Unit)** is selected. Do the same for Slot 3. Save the project.

Now click on **Options->Manage general station description files (GSD)**.

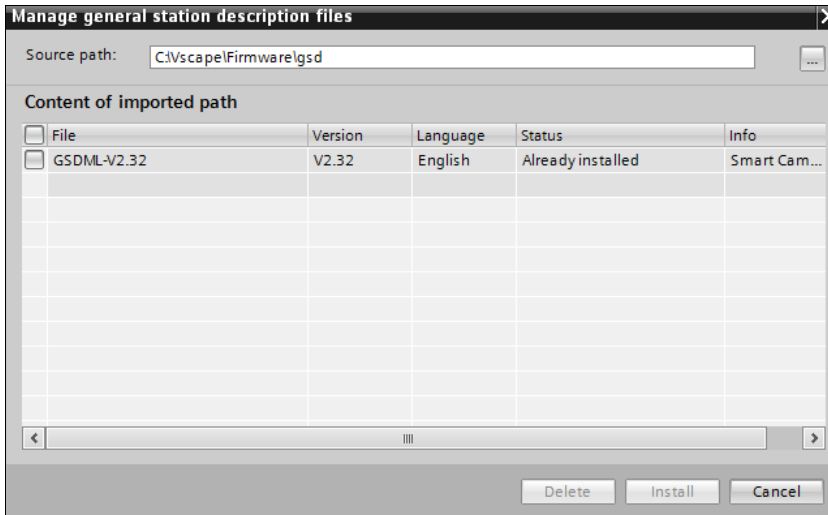

Browse to the following path: **C:\di-soric\VscapelFirmware\gsd\CS50 Sensor**. Select the appropriate GSD file by clicking the box next to the name, and click **Install**.

Click the tab that says **Network View**:

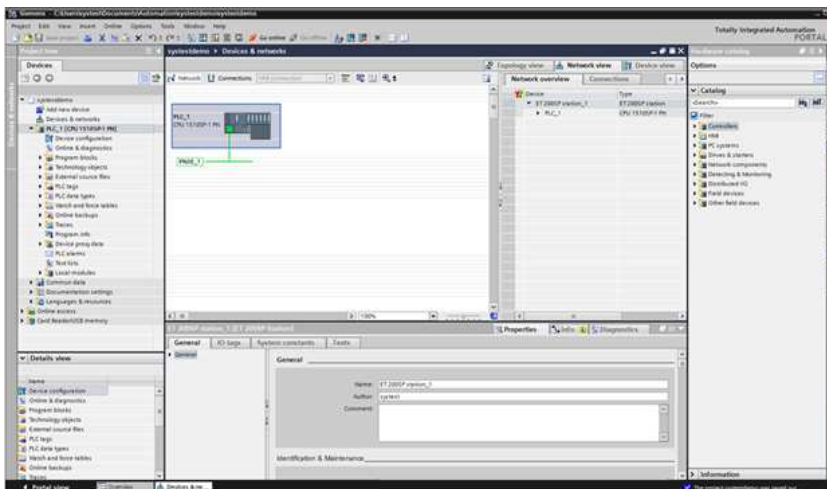

Look at the right panel and click **Hardware Catalog**. Use the arrows to open up the following area. **Other field devices->PROFINET IO ->General->di-soric->Smart Camera->CS50 Sensor**. Left-click on CS50 Sensor and hold it. Drag it to the left into the Devices and networks panel. Your screen will look like this:

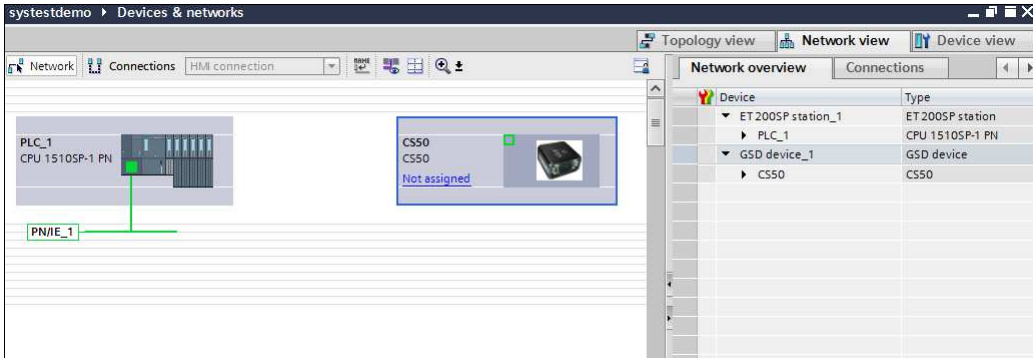

On the CS50 Sensor picture, click the **Not assigned** link, then click on **PLC_1.PROFINET IO-System**. This has just connected the CS50 Sensor to the PROFINET network.

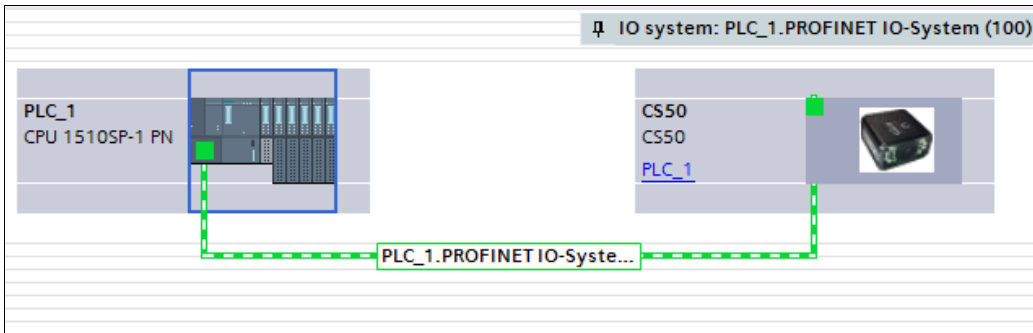

Double-click the picture of the CS50 Sensor. In the bottom pane you will see the following:

The screenshot displays a configuration window for a CS50 Sensor. The window has a tabbed interface with 'General', 'IO tags', 'System constants', and 'Texts'. The 'General' tab is active. On the left, a tree view shows the 'PROFINET interface [X1]' expanded to 'General'. The main area is titled 'General' and contains the following fields:

- Name: CS50
- Author: systest
- Comment: (empty text area)
- Rack: 0
- Slot: 0

Enter the name of the device in the Name: field. Then click Ethernet addresses on the left, and type in the IP address of the camera. This will allow the PLC to set the camera IP.

Importing an Example Program

From TIA Portal, open the example program from the menu **Project > Open**. Click the **Browse** button to locate the (**Circle_LocatorDemo.ap13**) program. The Circle_LocatorDemo is located in **C:\di-soric\Vscape\Tutorials and Samples\CS50 Sensor\PROFINET Demo\ TIAPortal_Demos\Circle_LocatorDemo\ TIACircle_LocatorDemo**. In the left pane in the **Devices** tab, open the PLC_1[CPU 1510SP-1 PN] arrow. Open the Program blocks arrow. Select all the blocks as shown below.

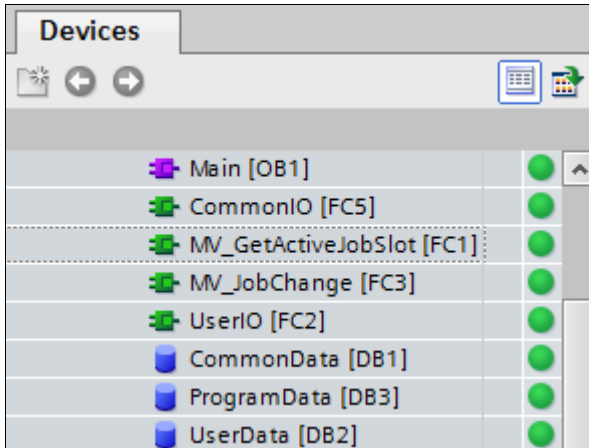

Right-click and copy. Go to your new project and open the same arrows, right-click on Program blocks, then click paste. Be sure to save your work. You may need to delete the Main [OB1] in the new project first.

Now back in the left pane of the Circle_LocatorDemo project, click on PLC data types, right-click, copy, and paste them into the new project PLC data types.

In the left pane of the Circle_LocatorDemo project, click on Watch and force tables. Right-click on Watch table_1, then copy. Paste into new project Watch and force tables. Be sure to save the project.

Your data in the new project should look like this:

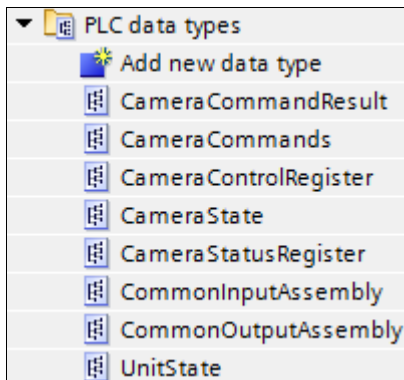

Checking the Mapping of IO

Depending on the order the PLC can load things, we may need to change the IO addresses in our block to match the Device Overview in the Device view screen.

Double-click on the CS50 Sensor picture, and the Device overview will be displayed to the right.

The image below is intended as an example only and may not exactly resemble your Device Overview.

Device overview						
...	Module	Rack	Slot	I address	Q address	Type
	▼ CS501898f5	0	0			CS50
	▶ Interface	0	0 X1			CS50
	Status_1	0	1	2...3		Status
	Control_1	0	2		2...3	Control
	Echo In_1	0	3	256...257		Echo In
	Echo Out_1	0	4		256...257	Echo Out
	Cmd Code Rslt_1	0	5	258...261		Cmd Code Rslt
	Cmd Code_1	0	6		258...261	Cmd Code
	Cmd Ret_1	0	7	262...265		Cmd Ret
	Cmd Arg_1	0	8		262...265	Cmd Arg
	State_1	0	9	266		State
		0	10			
		0	11			
		0	12			
		0	13			
		0	14			
		0	15			
		0	16			

From the Hardware catalog display to the far right, open the **Module** selection. You will see the following:

Module
Boolean In
Boolean Out
Float In
Float Out
Int In
Int Out
Long In
Long Out
Long String In
Long String Out
Short String In
Short String Out
VIO In
VIO Out

You must manually drag and drop “Boolean In_1” and “Float In_1” into the Device Overview pane. Click on “Boolean In_1”, and TIA will highlight the slot to drag it to. Repeat this for “Float In_1”. TIA will only allow you to insert them into their proper slot position.

Your device view should now look as follows. The example addresses shown will not be the same for your device.

Device overview								
			Module	Rack	Slot	I address	Q address	Type
			▼ CS501898f5	0	0			CS50
			▶ Interface	0	0 X1			CS50
			Status_1	0	1	2...3		Status
			Control_1	0	2		2...3	Control
			Echo In_1	0	3	256...257		Echo In
			Echo Out_1	0	4		256...257	Echo Out
			Cmd Code Rslt_1	0	5	258...261		Cmd Code Rslt
			Cmd Code_1	0	6		258...261	Cmd Code
			Cmd Ret_1	0	7	262...265		Cmd Ret
			Cmd Arg_1	0	8		262...265	Cmd Arg
			State_1	0	9	266		State
				0	10			
				0	11			
				0	12			
				0	13			
				0	14			
			Int In_1	0	15	4...23		Int In
				0	16			

You need to modify the PLC program blocks to agree with this display. On the left under the Devices pane, open the Program blocks arrow, and double-click on OB1 [OB1]. This will open a screen in the middle pane. Scroll this middle pane down until you see Network 1.

Change the numbers here to match with the Device overview display, as shown in the example below. Leave the DB_Number as-is.

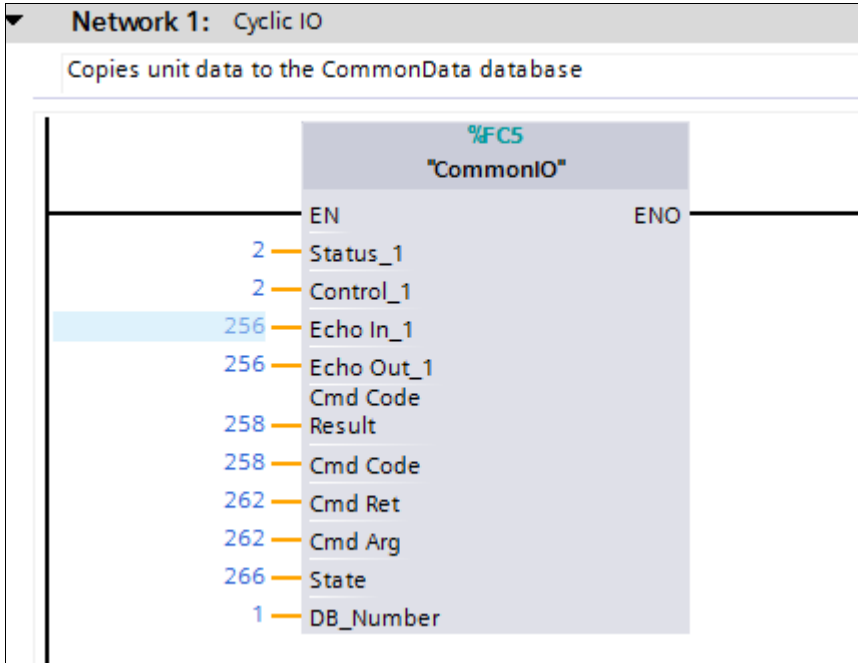

Repeat this for Network 4, using the Boolean In_1 address and the Float In_1 address from the Device Overview and put it in the BOOL_ADDR and FLOAT_ADDR respectively. Leave the DB_Number as-is.

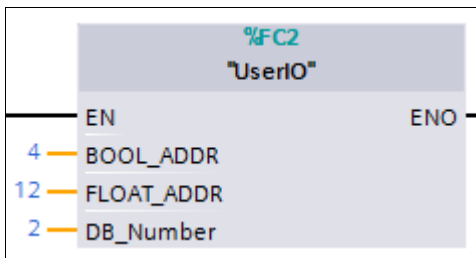

Be sure to save the project. Click the **PLC_1 {CPU 1510SP-1 PN}** top level, then click the compile icon.



There should be NO compile errors. If there are no errors, click the download icon.



You will see the following screen:

Extended download to device

Configured access nodes of "PLC_1"

Device	Device type	Slot	Type	Address	Subnet
PLC_1	CPU 1510SP-1 PN	1 X1	PN/IE	192.168.189.1	PN/IE_1

Type of the PG/PC interface:

PG/PC interface:

Connection to interface/subnet:

1st gateway:

Compatible devices in target subnet: Show all compatible devices

Device	Device type	Type	Address	Target device
---	---	PN/IE	Access address	---

Flash LED

Start search

Online status information:

Display only error messages

Load Cancel

Select your PC network interface, and change the Connection to interface/subnet to **PN/IE_1**. Click **Start Search**. PLC_1 should be displayed with the address you gave it. Click **Load**. If you see a screen similar to below, do a memory reset (MRES) on the PLC, and try to load again. If this continues to be an issue, click **Continue without synchronization** and continue.

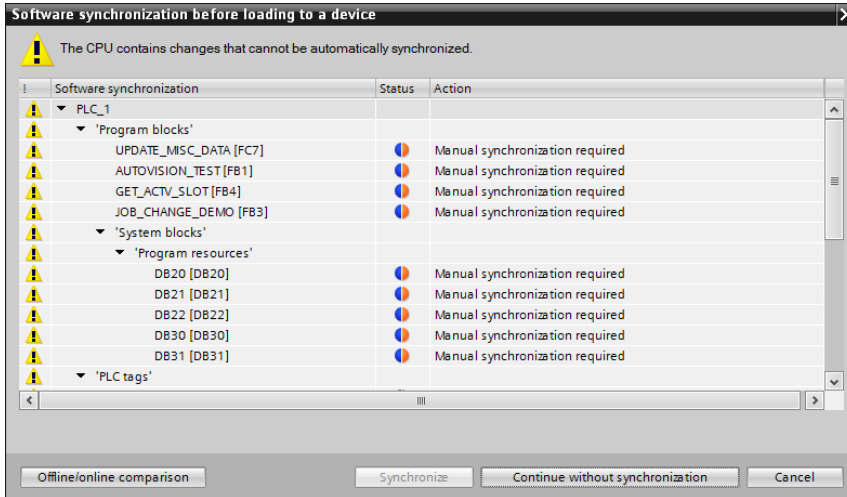

When downloading is working correctly you will see the following:

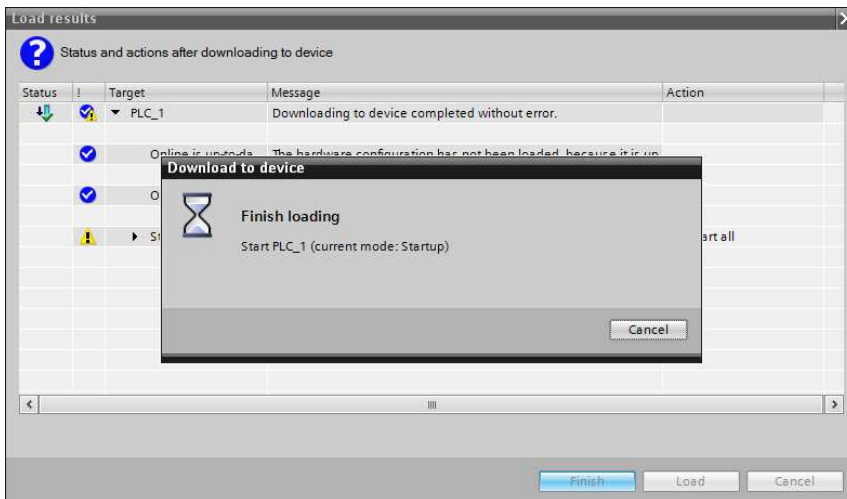

All LEDs on the PLC should be **GREEN**. Click **Go online**. You should see the following:

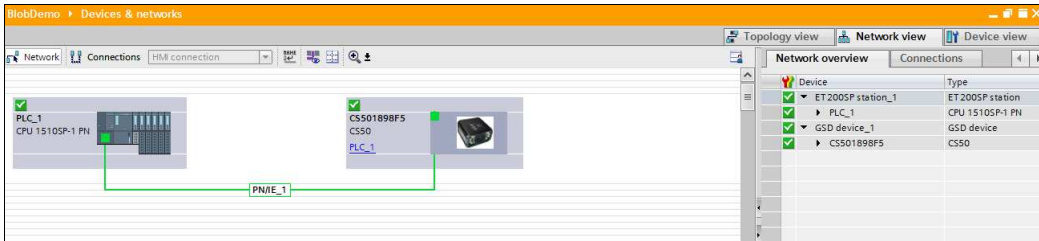

Troubleshooting

If all LEDs are not green, go offline and click the Accessible devices icon.



Click **Start search**. The PLC and the CS50 Sensor should be displayed here.

Accessible devices

Type of the PG/PC interface:

PG/PC interface:

Accessible nodes of the selected interface:

Device	Device type	Type	Address	MAC address
win-sn7tk0uevh9	SIMATIC-PC	PN/IE	192.168.20.175	00-05-1B-B0-2F-58
plc_1	CPU 1510SP-1 PN	PN/IE	192.168.189.1	28-63-36-48-AD-40
cs501898f5	Smart Camera	PN/IE	192.168.189.4	00-0B-43-18-6C-49

Flash LED

Start search

Online status information:

- Retrieving device information...
- Scan and information retrieval completed.
- Display only error messages

Show Cancel

If the name of the CS50 Sensor is not correct, you will not connect. The default name is cs50 with the last 3 of the MAC address. Ex: cs50186c49. Go back to the general settings of the CS50 Sensor in the device view, and change the name if required. Re-compile, and re-load. Try running again. This is the most common reason for not connecting.

Running the Demo

In the left pane click the Watch and force tables arrow. Double-click Watch table_1. The watch table will open in the center pane. Click on the monitor variables icon.

	Name	Address	Display format	Monitor v...	Modify value	
1	"ProgramData".ChangeJob		Bool	<input type="checkbox"/> FALSE		<input type="checkbox"/>
2	"ProgramData".New_JobSlot		DEC+/-	0		<input type="checkbox"/>
3	"ProgramData".Get_CurrentJobSlot		Bool	<input type="checkbox"/> FALSE		<input type="checkbox"/>
4	"ProgramData".Current_JobSlot		DEC+/-	2		<input type="checkbox"/>
5	"ProgramData".Trigger		Bool	<input type="checkbox"/> FALSE		<input type="checkbox"/>
6	"ProgramData".TotalTriggerCount		DEC+/-	0		<input type="checkbox"/>
7	"ProgramData".Pass		Bool	<input type="checkbox"/> FALSE		<input type="checkbox"/>
8	"ProgramData".TotalPassedCount		DEC+/-	0		<input type="checkbox"/>
9	"ProgramData".Fail		Bool	<input checked="" type="checkbox"/> TRUE		<input type="checkbox"/>
10	"ProgramData".TotalFailedCount		DEC+/-	0		<input type="checkbox"/>
11	"ProgramData".TotalInspCount		DEC+/-	0		<input type="checkbox"/>
12	"ProgramData".ResetCounters		Bool	<input type="checkbox"/> FALSE		<input type="checkbox"/>
13	"ProgramData".ResetError		Bool	<input type="checkbox"/> FALSE		<input type="checkbox"/>
14	"ProgramData".CommandResult.Fail		Bool	<input type="checkbox"/> FALSE		<input type="checkbox"/>
15	"ProgramData".CommandResult.No Job In Slot"		Bool	<input type="checkbox"/> FALSE		<input type="checkbox"/>
16	"ProgramData".CommandResult.UnknownCmd		Bool	<input type="checkbox"/> FALSE		<input type="checkbox"/>
17	"ProgramData".CommandResult.Success		Bool	<input type="checkbox"/> FALSE		<input type="checkbox"/>
18						<input type="checkbox"/>
19	"UserData".Instance 1Point1	%DB2.DB2	Floating-point nu...	470.7997		<input type="checkbox"/>
20	"UserData".Instance 1Point2	%DB2.DB2	Floating-point nu...	208.1492		<input type="checkbox"/>
21	"UserData".Instance 1Point3	%DB2.DB2	Floating-point nu...	-0.04094...		<input type="checkbox"/>
22	"UserData".Status[0]	%DB2.DBX0.0	Bool	<input type="checkbox"/> FALSE		<input type="checkbox"/>
23	"UserData".RadiusDatum	%DB2.DB2	Floating-point nu...	22.56597		<input type="checkbox"/>
24		<Add new>				<input type="checkbox"/>

The following operations can be tried here:

Change Job	Switch jobs from one slot to another
Get Current Job Slot	Displays the slot of the currently running job
Trigger an Inspection	Causes the camera to cycle through its inspection.
Reset Counters	Resets the TotalTriggerCount, TotalPassedCount, TotalFailedCount, and TotalInspCount to 0, and also sends a command to the camera to reset its internal counters.
Reset an Error condition	If an error occurs during run time, this will reset it, so demo may be continued.

Change Jobs + Get Current Job Slot

Be sure to store a job in a slot in the camera memory as described earlier. To execute this test properly, load another job into **Slot 2** of the camera. For example, the **BlobDemo** job. CS50 Software must be closed to run this demo.

Go to **Watch table_1**, and click the button with the glasses and “play” symbol. This begins the monitoring of data.

	Name	Address	Display format	Monitor value	Modify value	
1	*ProgramData*.ChangeJob		Bool	<input type="checkbox"/> FALSE		<input type="checkbox"/>
2	*ProgramData*.New_JobSlot		DEC+/-	1		<input type="checkbox"/>
3	*ProgramData*.Get_CurrentJobSlot		Bool	<input type="checkbox"/> FALSE		<input type="checkbox"/>
4	*ProgramData*.Current_JobSlot		DEC+/-	2		<input type="checkbox"/>
5	*ProgramData*.Trigger		Bool	<input type="checkbox"/> FALSE		<input type="checkbox"/>
6	*ProgramData*.TotalTriggerCount		DEC+/-	7		<input type="checkbox"/>
7	*ProgramData*.Pass		Bool	<input type="checkbox"/> FALSE		<input type="checkbox"/>
8	*ProgramData*.TotalPassedCount		DEC+/-	4		<input type="checkbox"/>
9	*ProgramData*.Fail		Bool	<input checked="" type="checkbox"/> TRUE		<input type="checkbox"/>
10	*ProgramData*.TotalFailedCount		DEC+/-	3		<input type="checkbox"/>
11	*ProgramData*.TotalInspCount		DEC+/-	7		<input type="checkbox"/>
12	*ProgramData*.ResetCounters		Bool	<input type="checkbox"/> FALSE		<input type="checkbox"/>
13	*UserData*.NumberOfParts	%DB2.DBW0	Hex	16#0000		<input type="checkbox"/>
14	*ProgramData*.ResetError		Bool	<input type="checkbox"/> FALSE		<input type="checkbox"/>
15	*ProgramData*.CommandResult.Fail		Bool	<input type="checkbox"/> FALSE		<input type="checkbox"/>
16	*ProgramData*.CommandResult.*No Job In Slot*		Bool	<input type="checkbox"/> FALSE		<input type="checkbox"/>
17	*ProgramData*.CommandResult.UnknownCmd		Bool	<input type="checkbox"/> FALSE		<input type="checkbox"/>
18	*ProgramData*.CommandResult.Success		Bool	<input type="checkbox"/> FALSE		<input type="checkbox"/>
19	<Add new>					

Using the Watch table_1 elements **ChangeJob** and **New_JobSlot**, click on the **Modify Value** column next to **New_JobSlot**, type 2, and type **Enter**. Click on the Modify value to the right of ChangeJob and enter **TRUE**. Click on the lightning bolt with a 1 at the top. This will set the job slot to 2. Then click the lightning bolt button again.

	Name	Address	Display format	Monitor value	Modify value		Comment
1	*ProgramData*.ChangeJob		Bool	<input type="checkbox"/> FALSE	TRUE	<input checked="" type="checkbox"/>	
2	*ProgramData*.New_JobSlot		DEC+/-	1	2	<input checked="" type="checkbox"/>	
3	*ProgramData*.Get_CurrentJobSlot		Bool	<input type="checkbox"/> FALSE		<input type="checkbox"/>	
4	*ProgramData*.Current_JobSlot		DEC+/-	2		<input type="checkbox"/>	
5	*ProgramData*.Trigger		Bool	<input type="checkbox"/> FALSE		<input type="checkbox"/>	
6	*ProgramData*.TotalTriggerCount		DEC+/-	0		<input type="checkbox"/>	
7	*ProgramData*.Pass		Bool	<input type="checkbox"/> FALSE		<input type="checkbox"/>	

The current job will be changed to the job in slot 2. To verify that this clears all changes made to the Modify value column, click on Modify value to the right of **Get_CurrentJobSlot**. Enter **TRUE**, and click on the lightning bolt button again.

Name	Address	Display format	Monitor value	Modify value
ProgramData.ChangeJob		Bool	<input type="checkbox"/> FALSE	
ProgramData.New_JobSlot		DEC+/-	1	
ProgramData.Get_CurrentJobSlot		Bool	<input type="checkbox"/> FALSE	TRUE
ProgramData.Current_JobSlot		DEC+/-	1	

You will see the current job listed to the right of **Current_JobSlot**. You can repeat this procedure, changing the slot back to **1** and verify that the current job slot is now **1**.

Trigger an Inspection and Reset Counters

Clear any changes made to the Modify value column. If you want to watch the inspection, be sure CS50 Software is running and connected to the device. Be sure the job is running. If you choose not to run CS50 Software, you can look at the LEDs on the device to confirm your triggers. Change the value to the right of **Trigger** to be **TRUE**, and click the lightning bolt button again.

BlobDemo > PLC_1 [CPU 1510SP-1 PN] > Watch and force tables > Watch table_1

Name	Address	Display format	Monitor value	Modify value	⚡
ProgramData.ChangeJob		Bool	<input type="checkbox"/> FALSE		<input type="checkbox"/>
ProgramData.New_JobSlot		DEC+/-	1		<input type="checkbox"/>
ProgramData.Get_CurrentJobSlot		Bool	<input type="checkbox"/> FALSE		<input type="checkbox"/>
ProgramData.Current_JobSlot		DEC+/-	1		<input type="checkbox"/>
ProgramData.Trigger		Bool	<input type="checkbox"/> FALSE	TRUE	<input type="checkbox"/>
ProgramData.TotalTriggerCount		DEC+/-	1		<input type="checkbox"/>
ProgramData.Pass		Bool	<input type="checkbox"/> FALSE		<input type="checkbox"/>

You will see the **InstancePoints**, **Status**, and **RadiusDatum** change based on the picture. The pass and fail bools will indicate whether the inspection has passed or failed. Also, the appropriate counters will have incremented. Each click of the lightning bolt button will cause an inspection which will bounce from one image to the next. One will pass and the next will fail.

To reset the counters, clear all settings in the Modify value column, and change the one next to **ResetCounters** to **TRUE**, and click the lightning bolt button again. You will see all the counters in blue reset to **0**.

Name	Address	Display format	Monitor value	Modify value
ProgramData.ChangeJob		Bool	<input type="checkbox"/> FALSE	
ProgramData.New_JobSlot		DEC+/-	1	
ProgramData.Get_CurrentJobSlot		Bool	<input type="checkbox"/> FALSE	
ProgramData.Current_JobSlot		DEC+/-	1	
ProgramData.Trigger		Bool	<input checked="" type="checkbox"/> TRUE	
ProgramData.TotalTriggerCount		DEC+/-	0	
ProgramData.Pass		Bool	<input checked="" type="checkbox"/> TRUE	
ProgramData.TotalPassedCount		DEC+/-	0	
ProgramData.Fail		Bool	<input type="checkbox"/> FALSE	
ProgramData.TotalFailedCount		DEC+/-	0	
ProgramData.TotalInspCount		DEC+/-	0	
ProgramData.ResetCounters		Bool	<input type="checkbox"/> FALSE	<input type="text" value="TRUE"/>
UserData.NumberOfParts	%DB2.DBW0	Hex	16#0002	
ProgramData.ResetError		Bool	<input type="checkbox"/> FALSE	

If you clear this again, set the Trigger to TRUE, and click the lightning bolt button again, you will notice that the counts start at 1 on both the PLC counters and CS50 Software counters.

Reset Error

If at any time there is an error indicated by a TRUE in any of the values below, you can clear the error by entering a TRUE to the right of **ResetError** and clicking the lightning bolt button. Reset it to **FALSE** and click the button again. Any errors in the values below should be cleared.

ProgramData.CommandResult.Fail	Bool	<input type="checkbox"/> FALSE
ProgramData.CommandResult.No Job In Slot	Bool	<input type="checkbox"/> FALSE
ProgramData.CommandResult.UnknownCmd	Bool	<input type="checkbox"/> FALSE
ProgramData.CommandResult.Success	Bool	<input type="checkbox"/> FALSE

PROFINET I/O Blob Count Demo Using STEP 7 and CS50 Sensor

This section describes how to use di-soric demo PLC code with a vision job and camera target.

The PROFINET I/O demo files can be found where CS50 Software is installed, in the folder: **C:\di-soric\Vscape\Tutorials and Samples\CS50 Sensor\PROFINET Demo\Step7_Demos\BlobDemo**. Open **BlobDemo.avp** and download it to the camera.

Notes:

- The camera communications protocol must be enabled for PROFINET I/O before it can be used in this environment. Refer to **Chapter 1, [Enabling Industrial Protocols](#)**, for information about enabling and switching communications protocols.
- CS50 Software jobs use di-soric Link functionality to accommodate PROFINET I/O communications between the camera and the PLC.

Important: PROFINET I/O allows the IP address and subnet mask of the camera to be assigned automatically by the PLC. In order to allow this, the CS50 Sensor may not have an assigned IP address on reboot until the PLC is set to Run mode. During this time, the CS50 Sensor will not be visible on the network for CS50 Software.

Overview

In this demonstration, you will learn how to load a saved job into the camera, establish connectivity via **PROFINET I/O** to a **Siemens S7 PLC**, and run some example programs that interface with the camera.

While evaluating PROFINET I/O capabilities, you will:

- **Begin with CS50 Software.**

Open a sample demo vision job in CS50 Software and use the Try Out feature to learn what to expect from the camera before it is connected to the PLC.

- **Prepare the PLC.**

Integrate the camera into the PLC environment with STEP 7 software and the GSD file.

- **Run the camera.**

Trigger the camera while it is online with the PLC and observe changes in the Inspection status as the PLC reconfigures the vision job's parameters.

CS50 Software Setup

Prior to starting CS50 Software, make sure the camera is either connected to the PLC or both PLC and camera are on the same physical network. Ensure that the PC, PLC, and camera have the same network class and corresponding subnet addresses.

Open CS50 Software and select the camera.

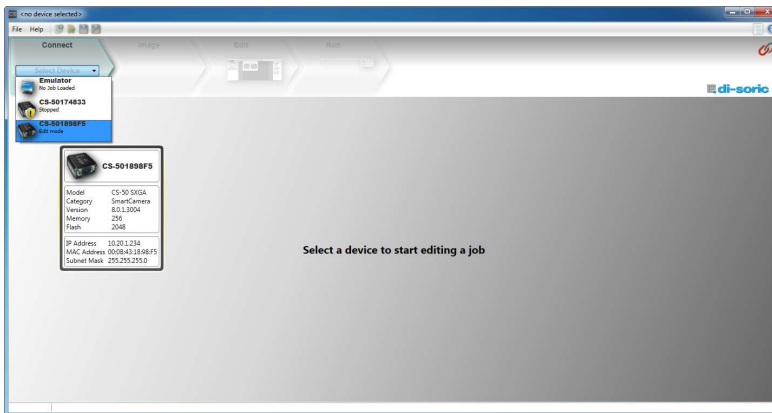

From the Image view, click the **Load a Job** button. Then navigate to **C:\di-soric\Vscape\Tutorials And Samples\CS50 Sensor\PROFINET Demo\Step7_Demos\BlobDemo**. Select **BlobDemo.avp**.

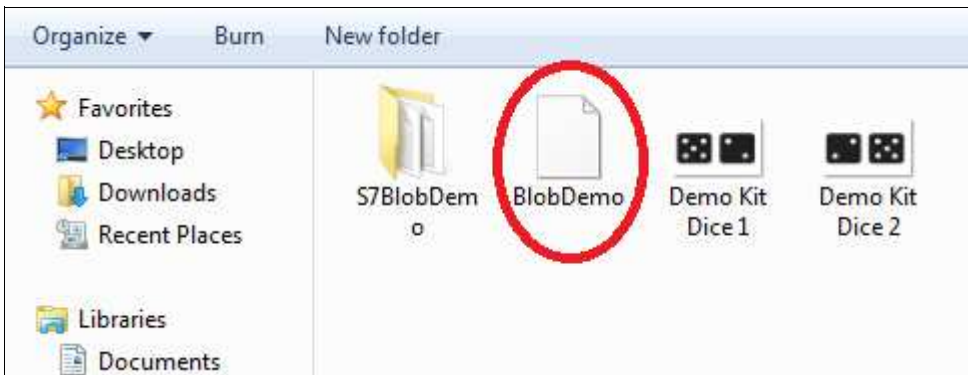

The demo job will include one tool: **Count Blobs**.

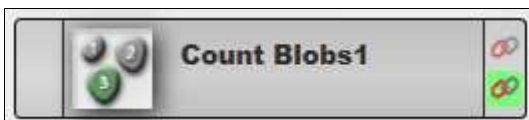

The Blob tool data item linked to the PROFINET I/O structure as shown here:

Tool Result	PLC IN
Number of parts	"UserData".NumberOfParts (%DB2.DBW0)

This data is transferred cyclically between the camera and PLC.

Once the job has loaded, the next step is to link the pre-saved images on the local PC. On the **Camera** button, click the far left icon to select and load an image.



A file browser will open. Then navigate to the same folder where the demo job was loaded PROFINET I/O Demo. If the images are located, the icon will change from a camera to a folder.

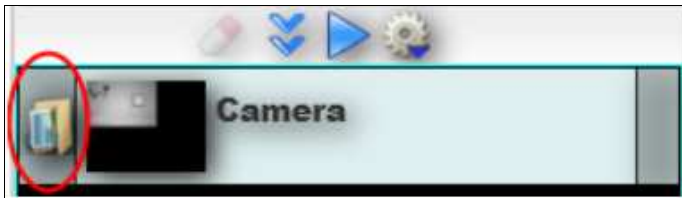

By clicking the **Try Job Once** icon, the application will cycle through the entire job with the loaded image.

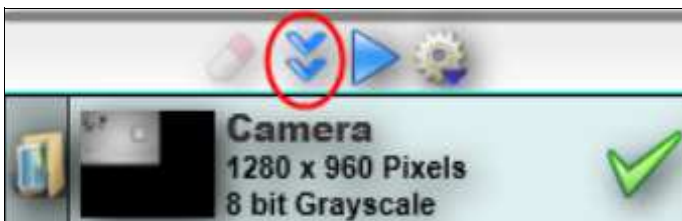

There are two images on file. One will pass the inspection and one will fail.

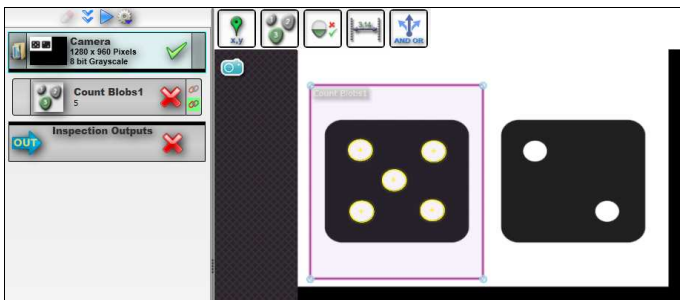
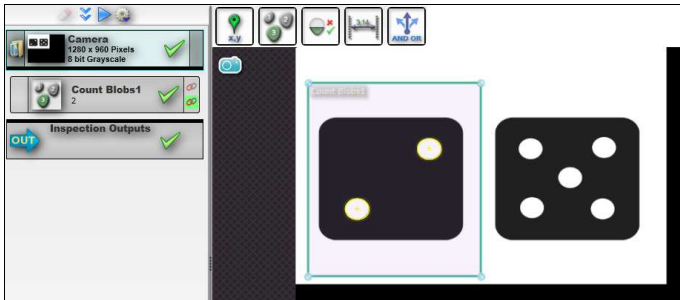

Now click the **Run** button on the top ribbon. This will download the job to the camera. At this point the job is ready to run and can be tested. However, in order to run the job change demo this job needs to be loaded into **Slot 1**. Click back to the **Edit** view from the top ribbon bar.

Click the slot icon and select Slot 1 or **New Slot** if no slots are currently in use.



Now the job and images will be saved to the flash memory of the camera.

STEP 7 Setup

This section was created using Siemens STEP 7 software version 5.5 + SP2 and an ET200S PLC, catalog number 6ES7 151-8AB01-0AB0, CPU Version 3.2. It was tested with a 315-2 PN/DP PLC, catalog number 6ES7-315-2EH13-0AB0, CPU Version 2.6.

First launch the SIMATIC Manager from the desktop.



Create a new project from the menu item **File > New**. Select the project location on disk then enter the name and click the **OK** button. In the example below, the name is **Start**. Once the project is first created, you will see the dialog. This dialog is the main entry point into the PLC program and hardware settings.

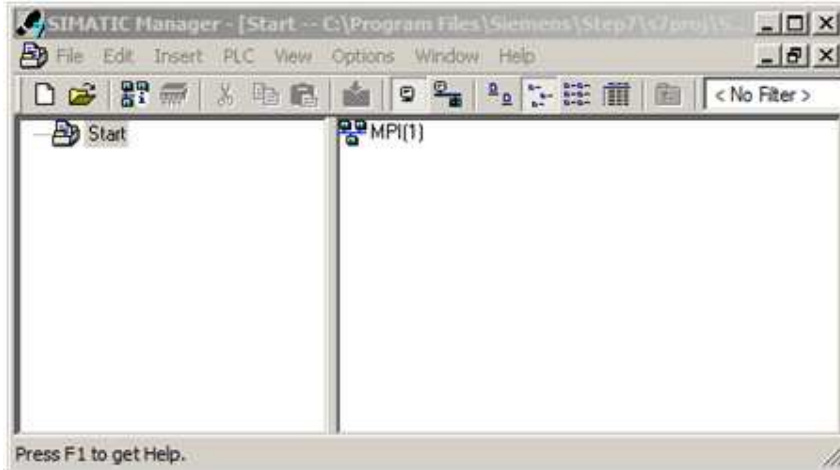

The PC may have multiple network cards so it's imperative to map the correct one to the SIMATIC software. From the menu, select Options > Set PG/PC Interface. This will open the Set PG/PC Interface dialog and list the available network cards. On the Access Path tab select the NIC card with (TCP/IP >) in the name.

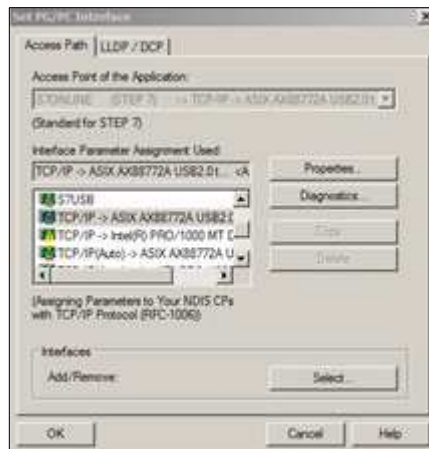

In the SIMATIC Manager dialog, right-click and select Insert New Object. This is where you will select the base station. For example, when configuring an ET200-s, select SIMATIC 300 Station since it's based on the 300 series CPU.

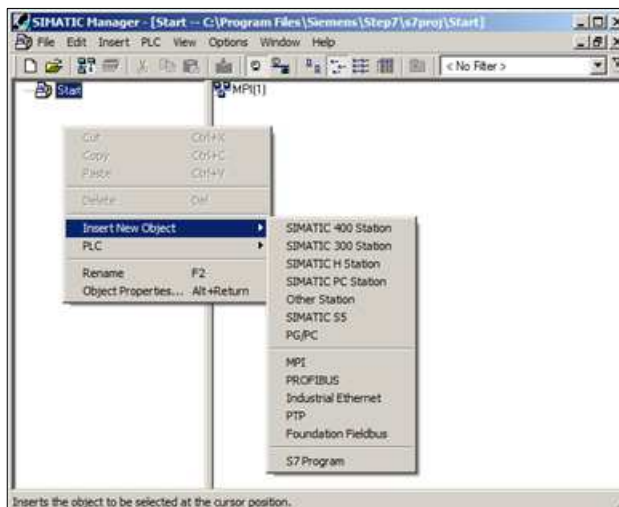

After the station has been added, right-click and add **Industrial Ethernet**.

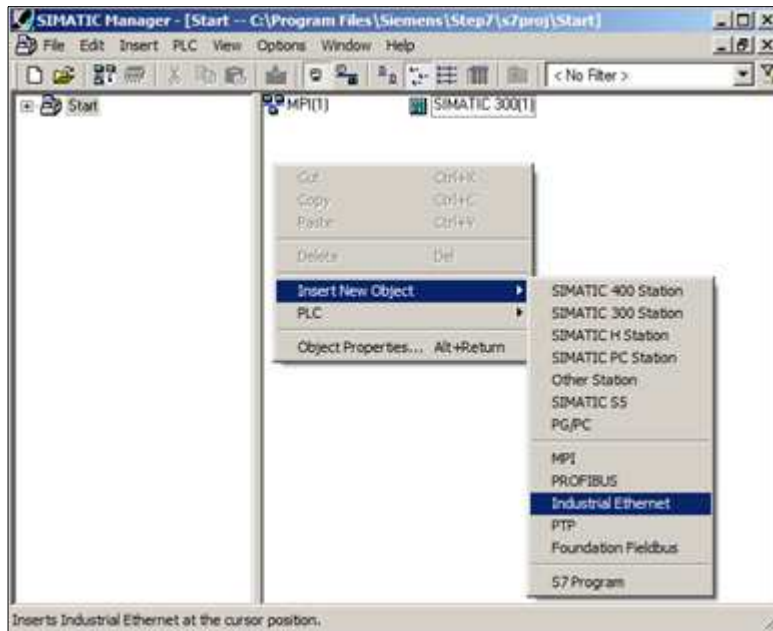

Expand the Start tree node on the left pane and click the station. On the right pane you will see a Hardware icon.



Double-click the **Hardware** icon to launch the **HW Config** dialog.

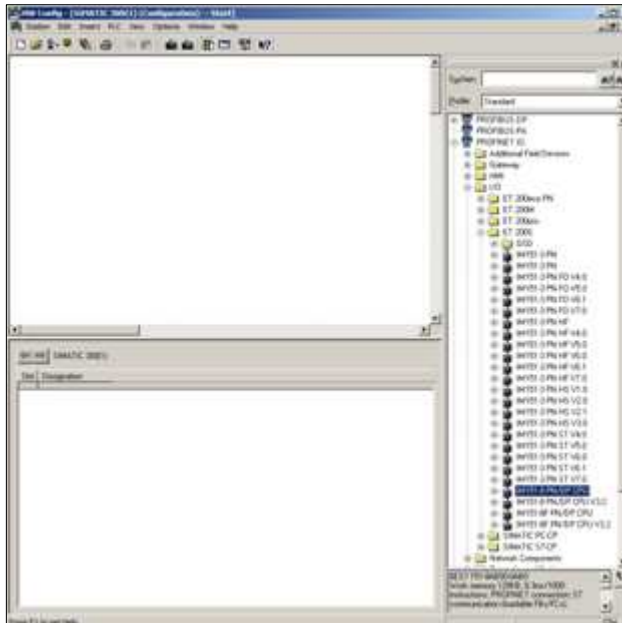

Make sure the **Catalog** is selected in the ribbon bar on the top. This will add a tree view on the right pane with all the available hardware devices.

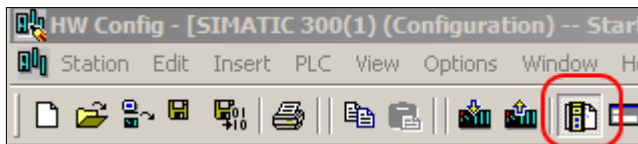

If the latest GSDML file hasn't been imported, follow the next steps to import.

GSDML

- Install the GSD file from the menu item **Options > Install GSD File**.
- Click the Browse button to locate the GSDML file **\\di-soric\Vscape\Firmware\gsd\CS50 Sensor**.

- The center pane will list the available GSDML files.

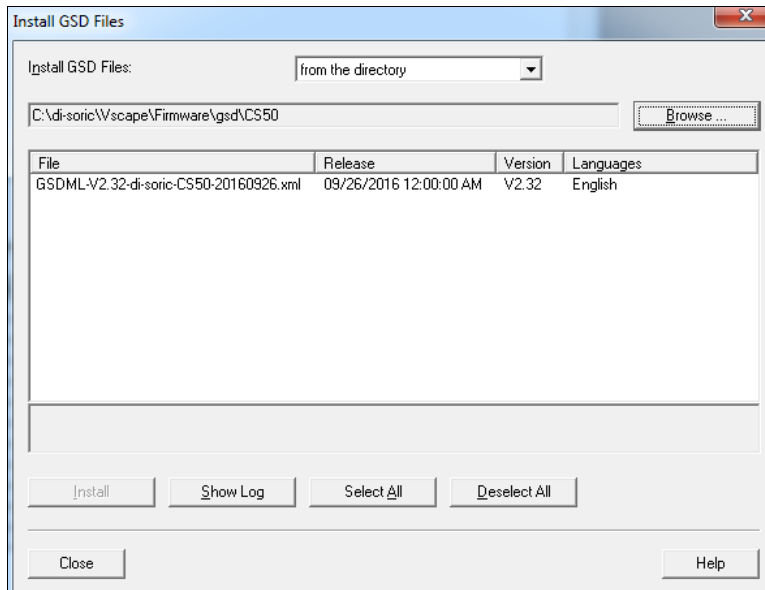

- Select the file and click the **Install** button.
- When finished, close the dialog.
- The camera should now be present in the PROFINET I/O section under **Additional Field Devices > General**.

Add the CPU from the catalog view by drag and drop or double-click. Make sure the catalog number and version matches the PLC exactly. The catalog number will be displayed on the bottom of the view.

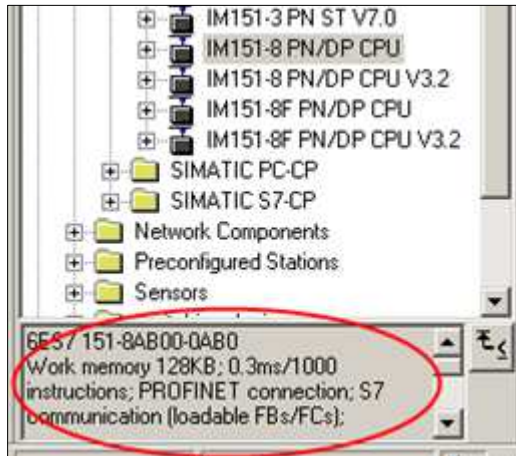

Some CPUs are modules that will require a generic rack to be added prior. If your PLC requires a rack, you will be prompted to add the rack prior to being allowed to insert the CPU module.

After the CPU is added, a popup dialog will prompt the Properties relating to the IP information.

Select **Ethernet(1)** on the bottom list box and enter the correct IP address of the CPU.

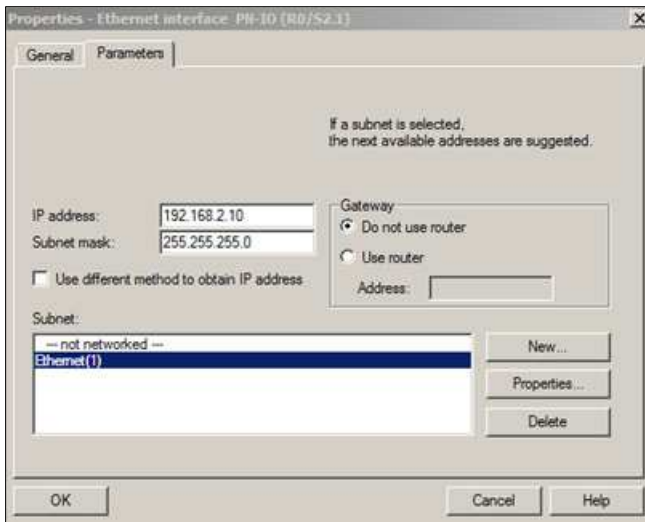

Once the CPU has been added, add any additional expansion modules, if installed. Click the CPU on the left pane and the bottom pane will list the available ports and slots.

Add the camera in the location (**PROFINET I/O > Additional Field Devices > General > di-soric**). The camera can be added by drag and drop to **Ethernet(1): PROFINET-I/O System (100)** or by selecting the **Ethernet(1)** line first and double-clicking the camera. Once the camera has been added the icon will appear on the configuration dialog.

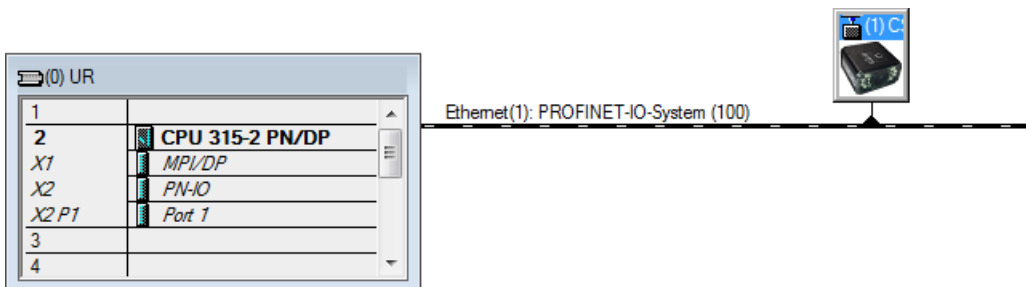

Once the camera has been added, double-click the icon to open the properties dialog. Under the device name, enter the existing name of the camera or a unique name.

Properties - CS501898f5

General | Identification

Short description: CS50
di-soric CS50

Order No./firmware: CS-50-BM2x-ES-Gx
Family: Smart Camera

Device name: CS501898f5

GSD file: GSDML-V2.32-di-soric-CS50-20160926.xml
Change Release Number...

Node in PROFINET IO System

Device number: 1 PROFINET-IO-System (100)

IP address: 10.20.1.234 Ethernet...

Assign IP address via IO controller

Comment:

OK Cancel Help

If a unique name is used, the device has to be manually updated. View Updating camera name section.

Click the camera icon and the data slot address mapping will be displayed below. Take note of the address values since they will be needed in the demo application. Since there is an infinite combination of modules and slot configurations, the addressing is unique to every setup.

The screenshot shows the SIMATIC Manager interface. At the top, a rack configuration window is open, showing a rack with four slots. Slot 2 contains a CPU 315-2 PN/DP. Below the rack, a PROFINET-IO-System (100) is connected to a camera icon. Below the rack configuration, a data slot address mapping table is displayed for the CS50189815 sensor.

Slot	M...	Order number	I address	Q address	Diagnostic address:	Comment
0	CS50	CS50-BM2-x-E...			2043*	
X1	Interf...				2042**	
X1	Port 1				2041**	
1	Status		0...1			
2	Control			0...1		
3	Echo		264...265			
4	Echo			264...265		
5	CmdL		256...259			
6	CmdL			260...263		
7	CmdA		260...263			
8	CmdL			256...259		
9	Status		266			
10						

This demo uses the **Int In** data. To the right under PROFINET I/O CS50 Sensor, click Int In. This will highlight its appropriate slot. Drag and drop this highlighted slot. The table should resemble the following:

The screenshot shows the SIMATIC Manager interface for a SIMATIC 300(1) system. A window titled '(0) UR' displays the rack configuration:

Slot	Module
1	
2	CPU 315-2 PN/DP
X1	MPI/DP
X2	PN-IO
X2 P1	Port 1
3	
4	

Below the rack configuration, a table shows the I/O configuration for the CS50 sensor (1) CS501898I5:

Slot	M...	Order number	I address	Q address	Diagnostic address:	Comment
0	CS50	CS50-BM2-x-E...			2043*	
X1	Interf...				2042**	
X1	Port 1				2041**	
1	Status		0...1			
2	Contra			0...1		
3	Echo		264...265			
4	Echo			264...265		
5	Cmd A		256...259			
6	Cmd A			260...263		
7	Cmd A		260...263			
8	Cmd A			256...259		
9	State		266			
10						
11						
12						
13						
14						
15	Int In		267...286			
16						

Once the hardware configuration has been completed, it's time to compile and download. Click the compile and save icon on the ribbon. If there are any configuration conflicts, the application will prompt a warning at this point.

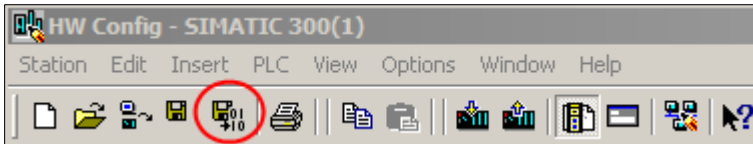

Once compiled, click the download icon on the ribbon to send the information to the PLC.

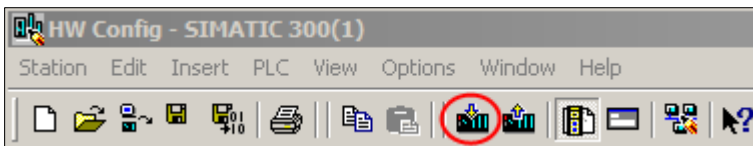

At this point close or minimize the **HW Config** dialog and re-visit the **SIMATIC Manager** dialog. The CPU should be added next to the Hardware icon and in the tree view in the left pane. Expand the CPU tree item and remaining child items below it.

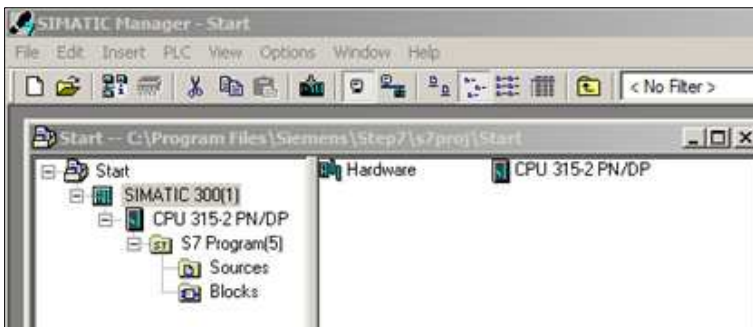

Click the Blocks node to view the program objects.

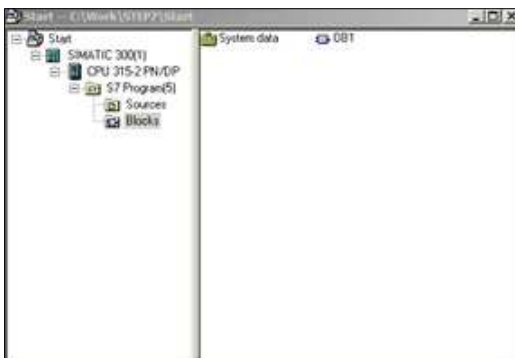

Updating Camera Name

From the HW Config dialog open **Edit Ethernet Node** from the menu item **PLC > Ethernet > Edit Ethernet Node**. From the SIMATIC Manager dialog open Edit Ethernet Node from the menu item **PLC > Edit Ethernet Node**.

Click the **Browse** button to open the node selection dialog.

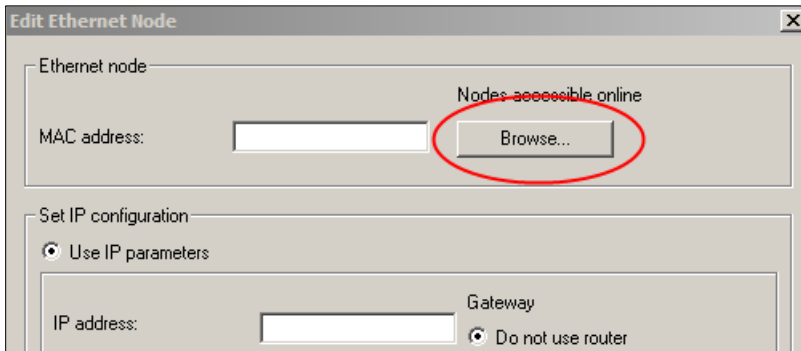

Select the camera and click the **OK** button.

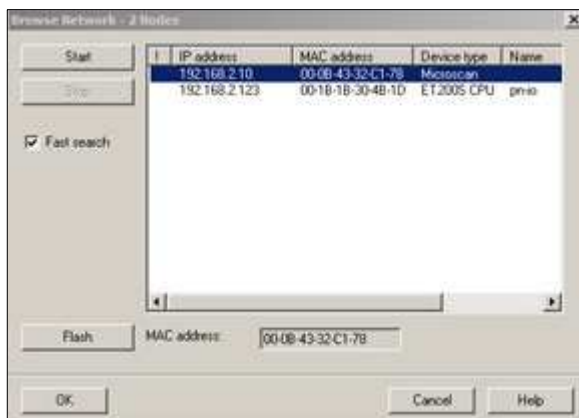

Edit the **Device Name**, if necessary, to match the name entered previously in the CS50 Sensor properties dialog, and click the **Assign Name** button.

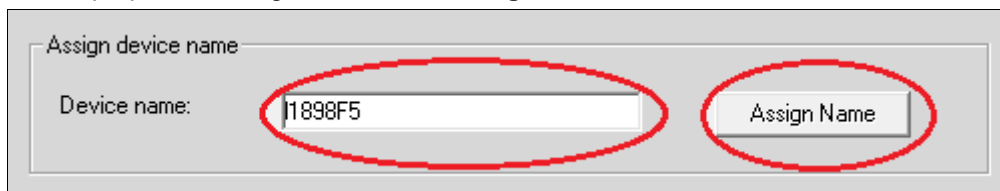

Importing Example Program

From the SIMATIC Manager, open the example program from the menu **File > Open**. Click the **Browse** button to locate the (BlobDemo) program. The BlobDemo is located in **\di-soric\Vscape\Tutorials and Samples\CS50 Sensor\PROFINET Demo\Step7_Demos\BlobDemo\S7BlobDemo\BlobDemo.s7p**.



Split both example and current projects in the dialog as shown.

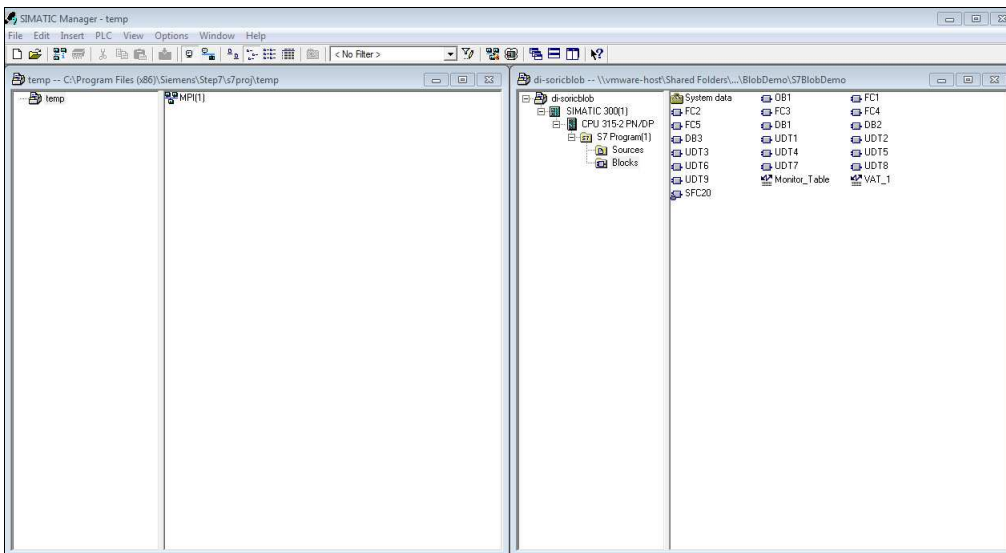

Select the objects minus the **System** data object and copy with a right-click and Copy or CTRL + C. Paste into the current project with a right-click > paste or CTRL + V. When prompted that **OB1** already exists, click the **Yes** button to overwrite it. Now the example program is imported to the current project.

Select the **Blocks** icon on the left pane. Then click the download button on the top ribbon. This will download the new copied functions and system data to the PLC. Now it's time to update the new addressing from the hardware installation prior. Double-click the **OB1** block to open the **LAD/STL/FBD** editor. OB1 is the main routine of the PLC program.

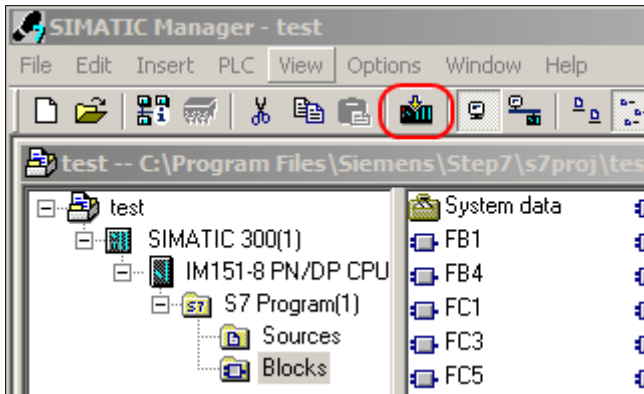

Scroll down to **Network 1**. This is where the data is mapped from the camera to the local data structure. **FC1** is a function that pushes the input data from the camera to the program structure. Click the numbers to match the address on the hardware as shown. Click the following buttons on the popup dialogs:

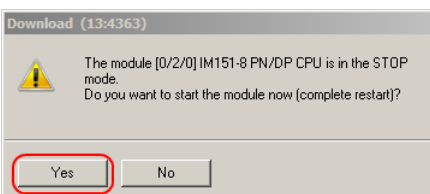
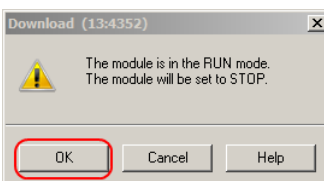
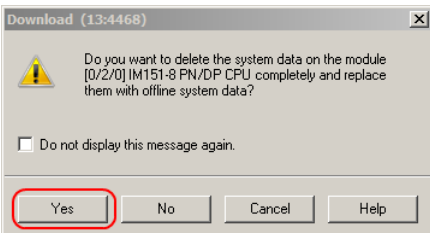
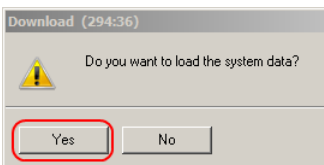
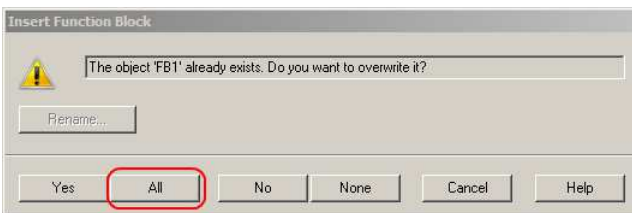
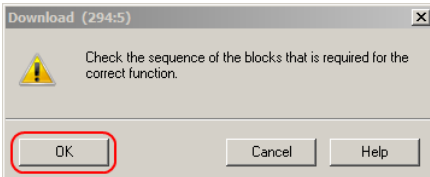

Note: This is the address mapping view of the CS50 Sensor module which is derived from the hardware config view.

	Slot	Module	Order number	I address	Q address	Diagnost
	0	CS50189915	CS50-BM2-x-E			2043*
"CommonIO_Exchange"	X1	Interface				2042*
EN	X1	Port 1				2041*
0 STATUS	1	Status		0..1		
	2	Control			0..1	
264 ECHO_IN	3	Echo In		264...265		
	4	Echo Out			264...265	
CMDCODERS	5	Cmd Code Ret		256...259		
256 LI	6	Cmd Code			260...263	
260 CMDRET	7	Cmd Ret		260...263		
	8	Cmd Arg			256...259	
266 STATE	9	State		266		
	10					
0 CONTROL	11					
	12					
264 ECHO_OUT	13					
	14					
260 CMDCODE	15	Int In		267...286		
256 CMDARG	16					

The addresses on the right must be copied to **Network 1** to match. Ex: HW config shows Status as address 0..1. Copy **0** into Network 1, **STATUS** value.

Repeat the same steps for **Network 6** to update the output data mapping. Keep in mind that all input addresses are under the (**I address**) column and the output addresses are under the (**Q address**) column. Save to the PC and download to the PLC.

Do a master reset and set the PLC to RUN mode. Make sure all LEDs indicate **good**.

Running the Demo

In the **SIMATIC Manager** dialog, double-click the **VAT_1** icon. This will open the variable table dialog for the data type demo. Maximize the internal dialog to increase the viewing area.

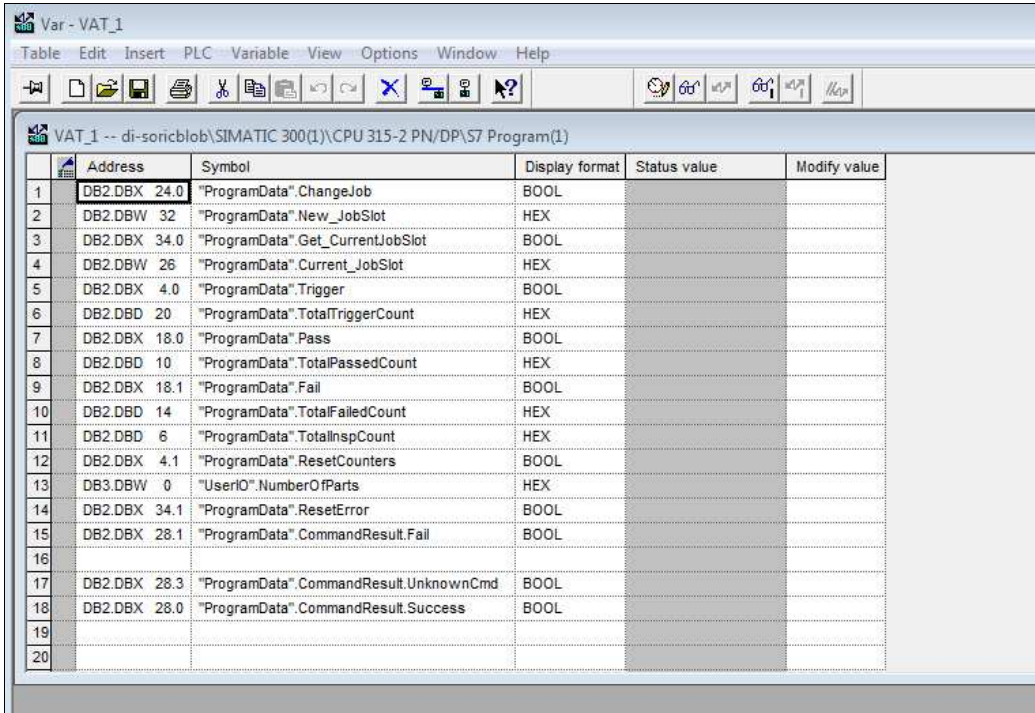

	Address	Symbol	Display format	Status value	Modify value
1	DB2.DBX 24.0	"ProgramData".ChangeJob	BOOL		
2	DB2.DBW 32	"ProgramData".New_JobSlot	HEX		
3	DB2.DBX 34.0	"ProgramData".Get_CurrentJobSlot	BOOL		
4	DB2.DBW 26	"ProgramData".Current_JobSlot	HEX		
5	DB2.DBX 4.0	"ProgramData".Trigger	BOOL		
6	DB2.DBD 20	"ProgramData".TotalTriggerCount	HEX		
7	DB2.DBX 18.0	"ProgramData".Pass	BOOL		
8	DB2.DBD 10	"ProgramData".TotalPassedCount	HEX		
9	DB2.DBX 18.1	"ProgramData".Fail	BOOL		
10	DB2.DBD 14	"ProgramData".TotalFailedCount	HEX		
11	DB2.DBD 6	"ProgramData".TotalInspCount	HEX		
12	DB2.DBX 4.1	"ProgramData".ResetCounters	BOOL		
13	DB3.DBW 0	"UserIO".NumberOfParts	HEX		
14	DB2.DBX 34.1	"ProgramData".ResetError	BOOL		
15	DB2.DBX 28.1	"ProgramData".CommandResult.Fail	BOOL		
16					
17	DB2.DBX 28.3	"ProgramData".CommandResult.UnknownCmd	BOOL		
18	DB2.DBX 28.0	"ProgramData".CommandResult.Success	BOOL		
19					
20					

To establish a live connection to the PLC, click the **Monitor Variable** button on the ribbon. This will update data from the PLC to the dialog. The top title bar will go blue and the bottom status will show run with a green progress bar.

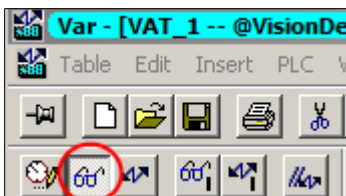

The following operations can be tried here:

Change Job	Switch jobs from one slot to another
Get Current Job Slot	Displays the slot of the currently running job
Trigger an Inspection	Causes the camera to cycle through its inspection.
Reset Counters	Resets the TotalTriggerCount, TotalPassedCount, TotalFailedCount, and TotalInspCount to 0, and also sends a command to the camera to reset its internal counters.
Reset an Error condition	If an error occurs during run time, this will reset it, so demo may be continued.

Change Jobs + Get Current Job Slot

Be sure to follow instructions in the CS50 Software Setup section to store a job in a slot in the camera memory. To properly execute this test, load another job into **slot 2** of the camera. For example, the Circle_LocatorDemo job. CS50 Software must be closed to run this Demo.

Using the VAT_1 elements **ChangeJob** and **New_JobSlot**. Click the **Modify value** column next to **New_JobSlot**, type 2, and type **Enter**. Click on the Modify Value column to the right of **ChangeJob** and enter TRUE. Click on the icon indicated at the top.

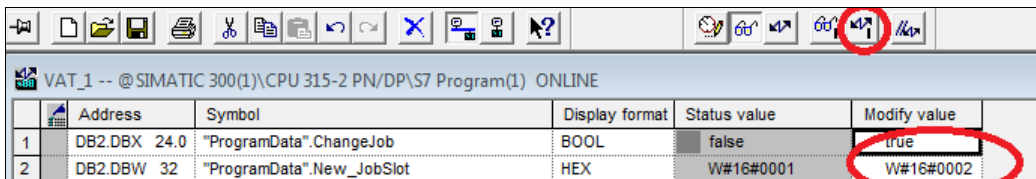

	Address	Symbol	Display format	Status value	Modify value
1	DB2.DBX 24.0	"ProgramData".ChangeJob	BOOL	false	true
2	DB2.DBW 32	"ProgramData".New_JobSlot	HEX	W#16#0001	W#16#0002

The current job will be changed to the job in **slot 2**. To verify this, clear all changes made to the **Modify value** column, and click Modify value to the right of **Get_CurrentJobSlot**. Enter **TRUE**, and click on the indicated icon again.

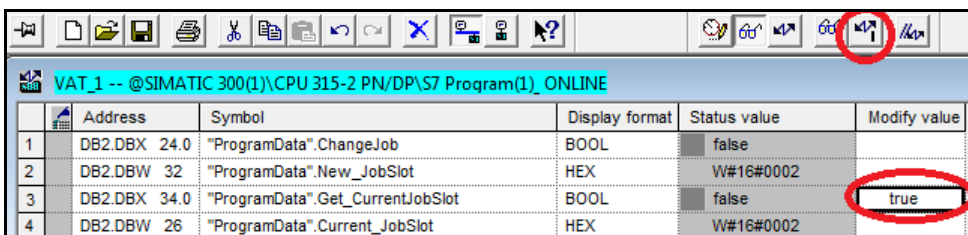

	Address	Symbol	Display format	Status value	Modify value
1	DB2.DBX 24.0	"ProgramData".ChangeJob	BOOL	false	
2	DB2.DBW 32	"ProgramData".New_JobSlot	HEX	W#16#0002	
3	DB2.DBX 34.0	"ProgramData".Get_CurrentJobSlot	BOOL	false	true
4	DB2.DBW 26	"ProgramData".Current_JobSlot	HEX	W#16#0002	

You will see the current job listed to the right of **Current_JobSlot**. You may repeat this procedure changing the slot back to **1** and verify the current job slot is now **1**.

Trigger Inspection and Reset Counters

Be sure the current job selected is **slot 1**. Clear any changes made to the **Modify value** column. If you want to watch the inspection, be sure CS50 Software is running, and connected to the device. Be sure the job is running. If you choose not to run CS50 Software, you may look at the LEDs on the device to confirm your triggers. Change the value to the right of Trigger to **TRUE**, and click the indicated icon.

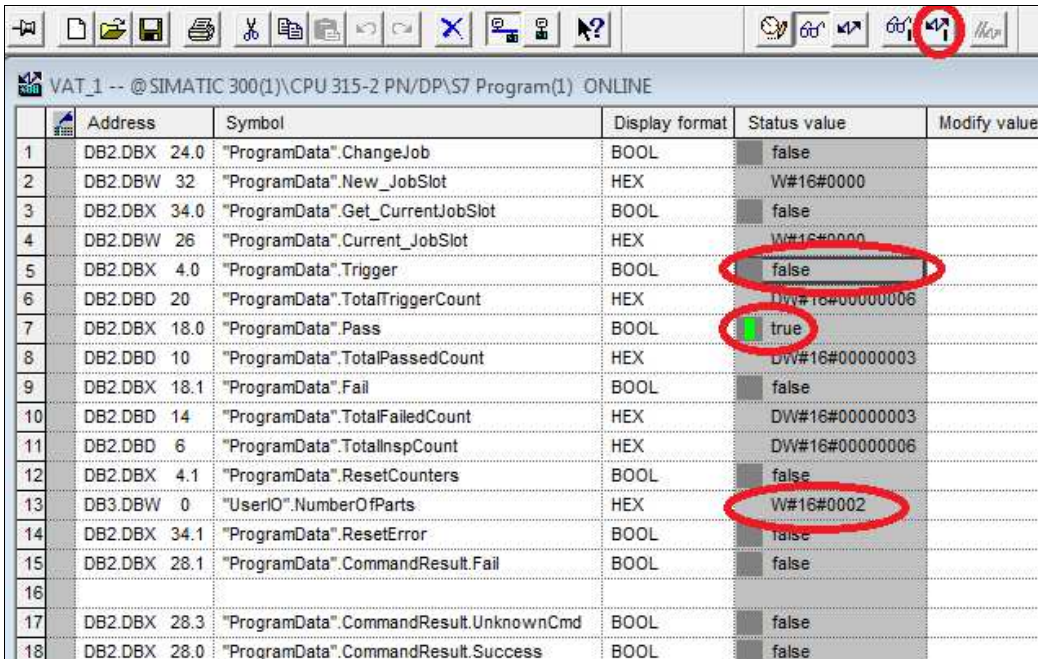

	Address	Symbol	Display format	Status value	Modify value
1	DB2.DBX 24.0	"ProgramData".ChangeJob	BOOL	false	
2	DB2.DBW 32	"ProgramData".New_JobSlot	HEX	W#16#0000	
3	DB2.DBX 34.0	"ProgramData".Get_CurrentJobSlot	BOOL	false	
4	DB2.DBW 26	"ProgramData".Current_JobSlot	HEX	W#16#0000	
5	DB2.DBX 4.0	"ProgramData".Trigger	BOOL	false	
6	DB2.DBD 20	"ProgramData".TotalTriggerCount	HEX	DW#16#00000006	
7	DB2.DBX 18.0	"ProgramData".Pass	BOOL	true	
8	DB2.DBD 10	"ProgramData".TotalPassedCount	HEX	DW#16#00000003	
9	DB2.DBX 18.1	"ProgramData".Fail	BOOL	false	
10	DB2.DBD 14	"ProgramData".TotalFailedCount	HEX	DW#16#00000003	
11	DB2.DBD 6	"ProgramData".TotalInspCount	HEX	DW#16#00000006	
12	DB2.DBX 4.1	"ProgramData".ResetCounters	BOOL	false	
13	DB3.DBW 0	"UserIO".NumberOfParts	HEX	W#16#0002	
14	DB2.DBX 34.1	"ProgramData".ResetError	BOOL	false	
15	DB2.DBX 28.1	"ProgramData".CommandResult.Fail	BOOL	false	
16					
17	DB2.DBX 28.3	"ProgramData".CommandResult.UnknownCmd	BOOL	false	
18	DB2.DBX 28.0	"ProgramData".CommandResult.Success	BOOL	false	

You will see the **NumberOfParts** change to either **2** or **5**. The pass and fail bools will indicate whether the inspection has passed or failed. Also, the appropriate counters will have incremented. Each press of the icon will cause an inspection which will bounce from one image to the next. One will pass and the next will fail.

Reset Counters

To reset the counters, clear all settings in the Modify value column, and change the one next to **ResetCounters** to **TRUE**, and click the icon again. You will see all the counters in blue reset to **0**.

	Address	Symbol	Display format	Status value	Modify value
1	DB2.DBX 24.0	"ProgramData".ChangeJob	BOOL	false	
2	DB2.DBW 32	"ProgramData".New_JobSlot	HEX	W#16#0000	
3	DB2.DBX 34.0	"ProgramData".Get_CurrentJobSlot	BOOL	false	
4	DB2.DBW 26	"ProgramData".Current_JobSlot	HEX	W#16#0000	
5	DB2.DBX 4.0	"ProgramData".Trigger	BOOL	false	
6	DB2.DBD 20	"ProgramData".TotalTriggerCount	HEX	DW#16#00000000	
7	DB2.DBX 18.0	"ProgramData".Pass	BOOL	true	
8	DB2.DBD 10	"ProgramData".TotalPassedCount	HEX	DW#16#00000000	
9	DB2.DBX 18.1	"ProgramData".Fail	BOOL	false	
10	DB2.DBD 14	"ProgramData".TotalFailedCount	HEX	DW#16#00000000	
11	DB2.DBD 6	"ProgramData".TotalInspCount	HEX	DW#16#00000000	
12	DB2.DBX 4.1	"ProgramData".ResetCounters	BOOL	false	true
13	DB3.DBW 0	"UserIO".NumberOfParts	HEX	W#16#0002	
14	DB2.DBX 34.1	"ProgramData".ResetError	BOOL	false	
15	DB2.DBX 28.1	"ProgramData".CommandResult.Fail	BOOL	false	
16					
17	DB2.DBX 28.3	"ProgramData".CommandResult.UnknownCmd	BOOL	false	
18	DB2.DBX 28.0	"ProgramData".CommandResult.Success	BOOL	false	
19					

If you clear this again and set the Trigger to **TRUE**, and click the lightning bolt button again, you will notice that the counts start at **1** on both the PLC counters and CS50 Software counters.

Reset Error

If at any time there is an error indicated by a TRUE in any of the values below, you can clear the error by entering a TRUE to the right of **ResetError** and clicking the icon. Reset it to **FALSE** and click the button again. Any errors in the values below should be cleared.

DB2.DBX 28.1	"ProgramData".CommandResult.Fail	BOOL	false
DB2.DBX 28.3	"ProgramData".CommandResult.UnknownCmd	BOOL	false
DB2.DBX 28.0	"ProgramData".CommandResult.Success	BOOL	false

PROFINET I/O Circle Locate Demo Using STEP 7 and CS50 Sensor

This section describes how to use di-soric demo PLC code with a vision job and camera target.

The PROFINET I/O demo files can be found where CS50 Software is installed, in the folder: **C:\di-soric\Vscape\Tutorials and Samples\CS50 Sensor\PROFINET Demo\Step7_Demos\Circle_LocatorDemo**. Open **Circle_LocatorDemo.avp** and download it to the camera.

Notes:

- The camera communications protocol must be enabled for PROFINET I/O before it can be used in this environment. Refer to **Chapter 1, [Enabling Industrial Protocols](#)**, for information about enabling and switching communications protocols.
- CS50 Software jobs use di-soric Link functionality to accommodate PROFINET I/O communications between the camera and the PLC.

Important: PROFINET I/O allows the IP address and subnet mask of the camera to be assigned automatically by the PLC. In order to allow this, the CS50 Sensor may not have an assigned IP address on reboot until the PLC is set to Run mode. During this time, the CS50 Sensor will not be visible on the network for CS50 Software.

Overview

In this demonstration, you will learn how to load a saved job into the camera, establish connectivity via **PROFINET I/O** to a **Siemens S7 PLC**, and run some example programs that interface with the camera.

While evaluating PROFINET I/O capabilities, you will:

- **Begin with CS50 Software.**

Open a sample demo vision job in CS50 Software and use the Try Out feature to learn what to expect from the camera before it is connected to the PLC.

- **Prepare the PLC.**

Integrate the camera into the PLC environment with STEP 7 software and the GSD file.

- **Run the camera.**

Trigger the camera while it is online with the PLC and observe changes in the Inspection status as the PLC reconfigures the vision job's parameters.

CS50 Software Setup

Prior to starting CS50 Software, make sure the camera is either connected to the PLC or both PLC and camera are on the same physical network. Ensure that the PC, PLC, and camera have the same network class and corresponding subnet addresses.

Open CS50 Software and select the camera.

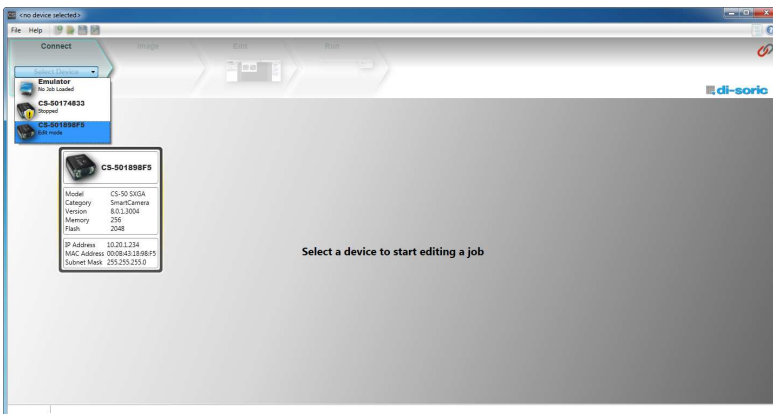

From the Image view, click the **Load a Job** button. Then navigate to **C:\di-soric\VscapeTutorials And Samples\CS50 Sensor\PROFINET demo\Step7_Demos\Circle_LocatorDemo**. Select **Circle_LocatorDemo.avp**.

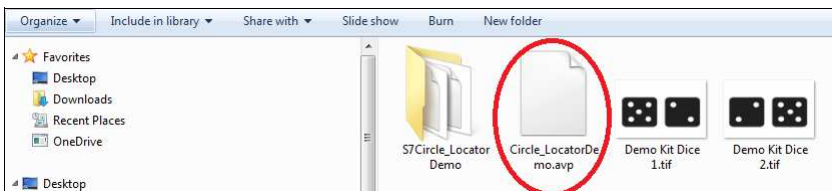

The demo job will include two tools: **Locate Shape** and **Circle**.

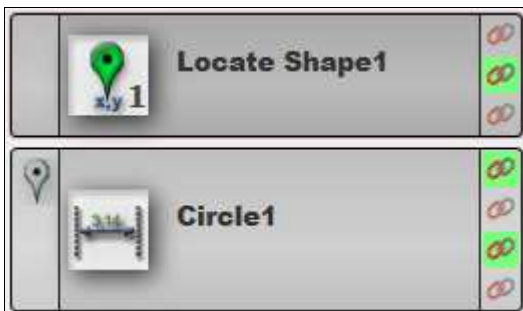

The PROFINET I/O structure is shown here:

Tool Result	PLC IN
Instance Point1	"UserData".Instance1Point1(%DB2.DBD2)
Instance Point2	"UserData".Instance1Point2(%DB2.DBD6)
Instance Point3	"UserData".InstancePoint3(%DB2.DBD10)
Status	"UserData".Status[0](%DB2.DBX0.0)
RadiumDatum	"UserData".RadiusDatum(%DB2.DBD14)

This data is transferred cyclically between the camera and PLC.

Once the job has loaded, the next step is to link the pre-saved images on the local PC. On the **Camera** button, click the far left icon to select and load an image.

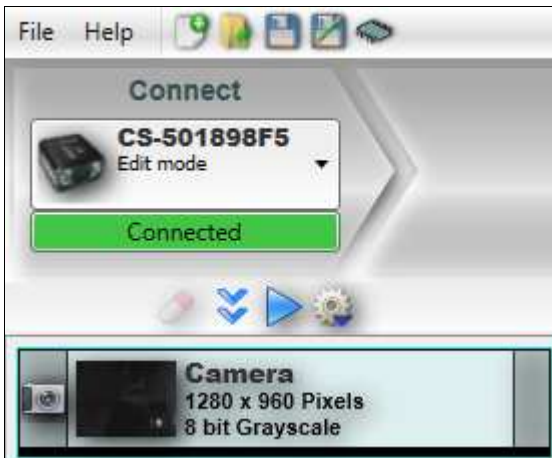

A file browser will open. Then navigate to the same folder where the demo job was loaded PROFINET I/O Demo. If the images are located, the icon will change from a camera to a folder.

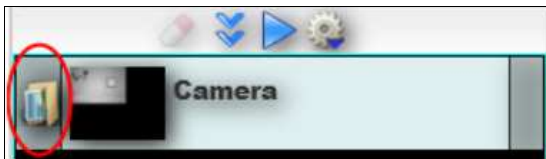

By clicking the **Try Job Once** icon, the application will cycle through the entire job with the loaded image.

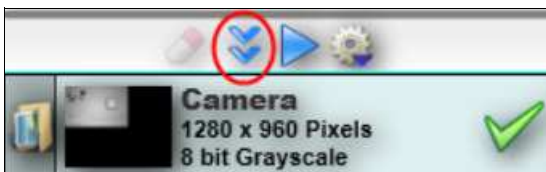

There are two images on file. One will pass the inspection and one will fail.

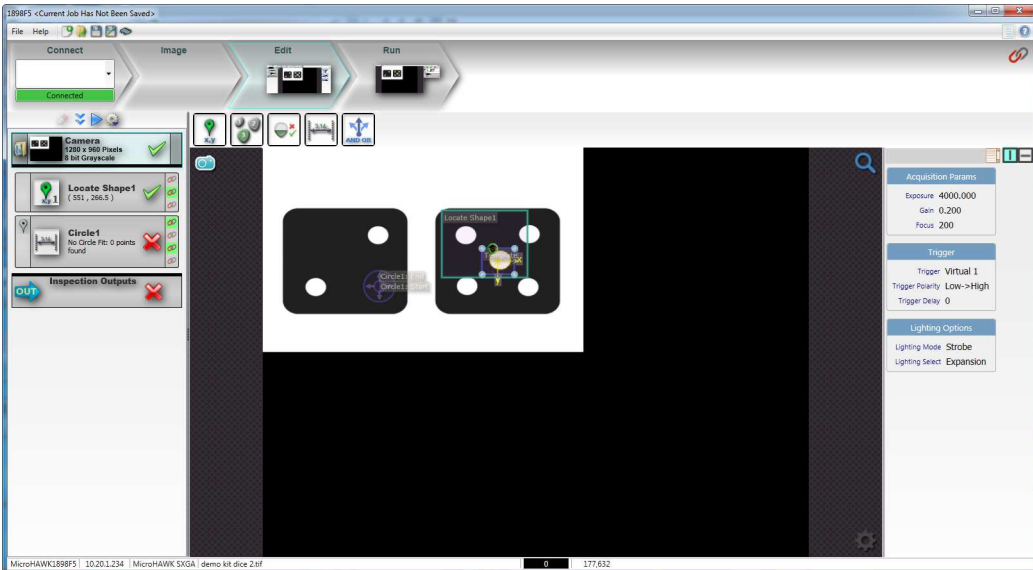
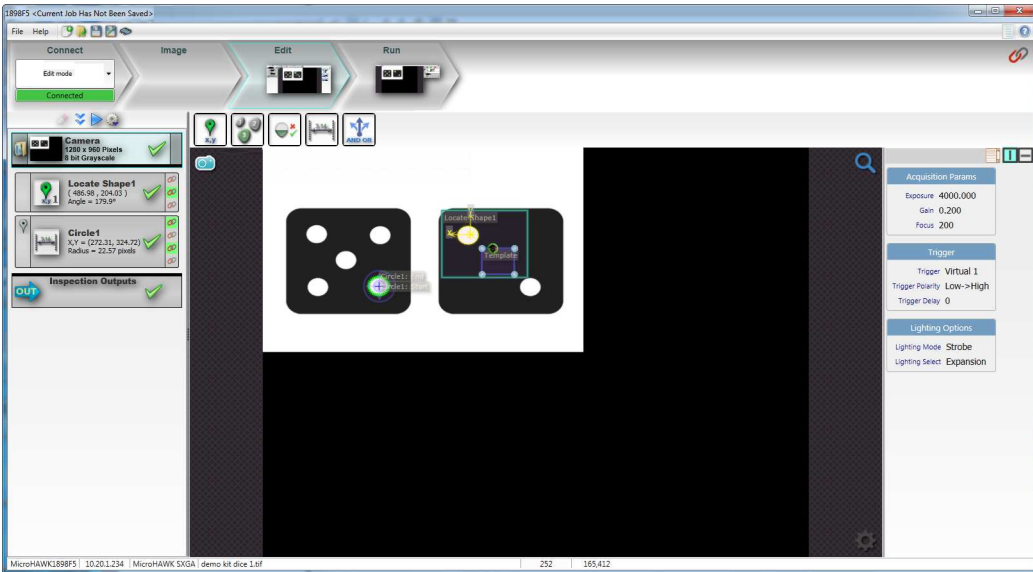

Now click the **Run** button on the top ribbon. This will download the job to the camera. At this point the job is ready to run and can be tested. However, in order to run the job change demo this job needs to be loaded into **Slot 1**. Click back to the **Edit** view from the top ribbon bar.

Click the slot icon and select Slot 1 or **New Slot** if no slots are currently in use.



Now the job and images will be saved to the flash memory of the camera.

STEP 7 Setup

This section was created using Siemens STEP 7 software version 5.5 + SP2 and an ET200S PLC, catalog number 6ES7 151-8AB01-0AB0, CPU Version 3.2. It was tested with a 315-2 PN/DP PLC, catalog number 6ES7-315-2EH13-0AB0, CPU Version 2.6.

First launch the SIMATIC Manager from the desktop.



Create a new project from the menu item **File > New**. Select the project location on disk then enter the name and click the **OK** button. In the example below, the name is **Start**. Once the project is first created, you will see the dialog. This dialog is the main entry point into the PLC program and hardware settings.

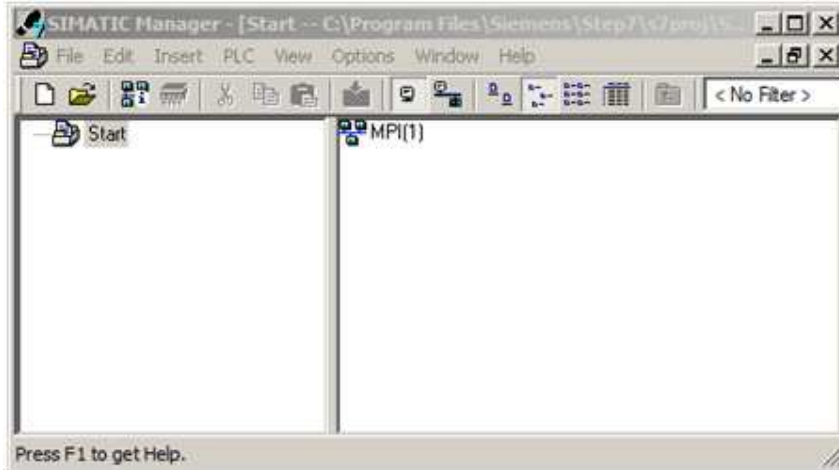

The PC may have multiple network cards so it's imperative to map the correct one to the SIMATIC software. From the menu, select Options > Set PG/PC Interface. This will open the Set PG/PC Interface dialog and list the available network cards. On the Access Path tab select the NIC card with (TCP/IP >) in the name.

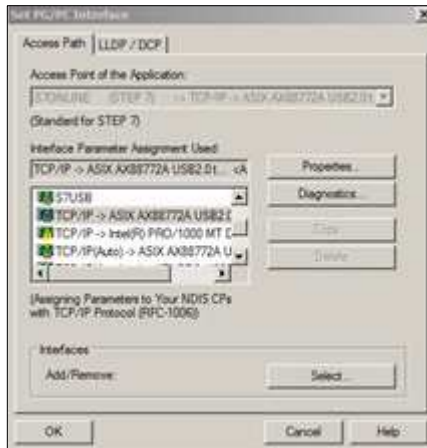

In the SIMATIC Manager dialog, right-click and select Insert New Object. This is where you will select the base station. For example, when configuring an ET200-s, select SIMATIC 300 Station since it's based on the 300 series CPU.

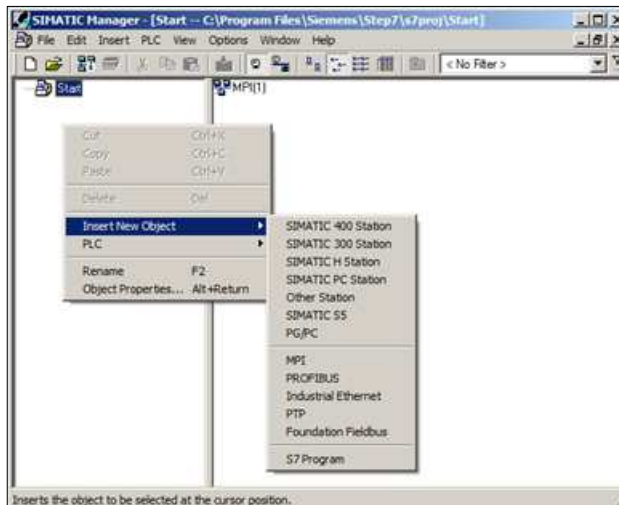

After the station has been added, right-click and add **Industrial Ethernet**.

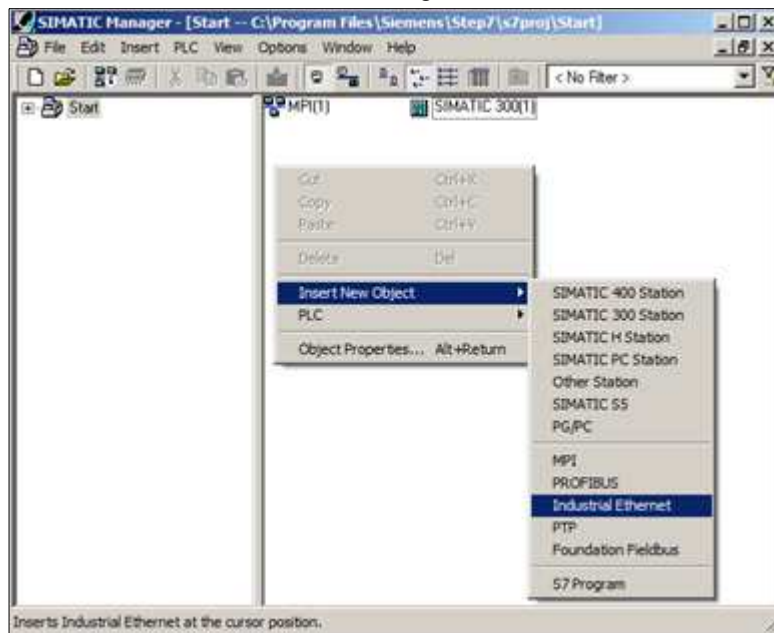

Expand the Start tree node on the left pane and click the station. On the right pane you will see a Hardware icon.



Double-click the **Hardware** icon to launch the **HW Config** dialog.

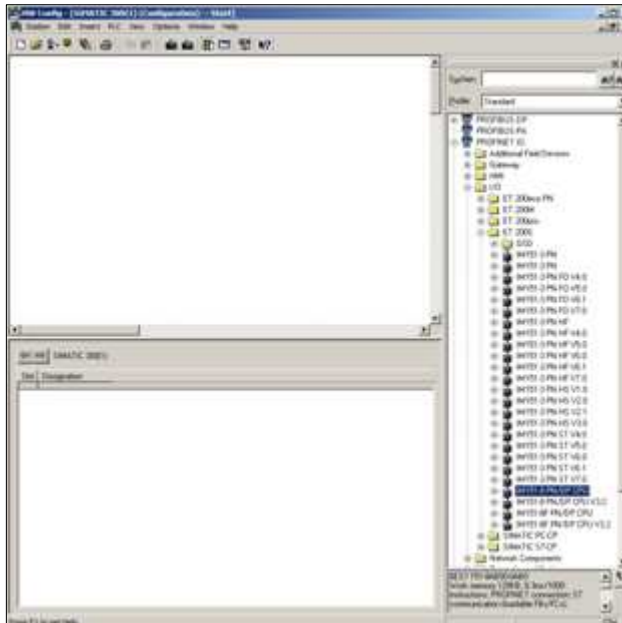

Make sure the **Catalog** is selected in the ribbon bar on the top. This will add a tree view on the right pane with all the available hardware devices.

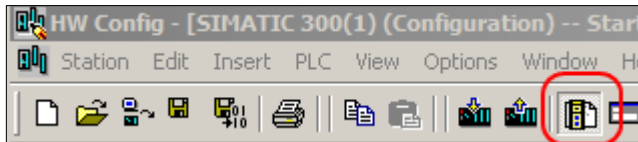

If the latest GSDML file hasn't been imported, follow the next steps to import.

GSDML

- Install the GSD file from the menu item **Options > Install GSD File**.
- Click the Browse button to locate the GSDML file **\\di-soric\Vscape\Firmware\gsd\CS50 Sensor**.

- The center pane will list the available GSDML files.

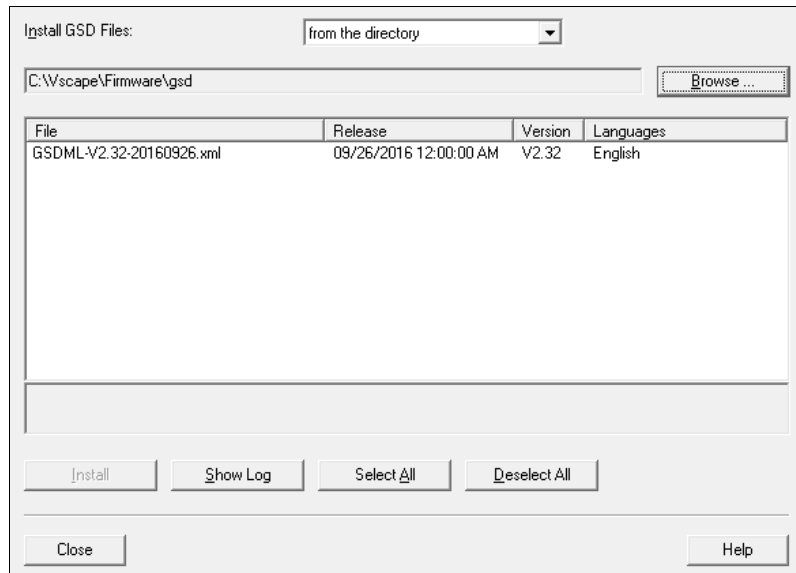

- Select the file and click the **Install** button.
- When finished, close the dialog.
- The camera should now be present in the PROFINET I/O section under **Additional Field Devices > General**.

Add the CPU from the catalog view by drag and drop or double-click. Make sure the catalog number and version matches the PLC exactly. The catalog number will be displayed on the bottom of the view.

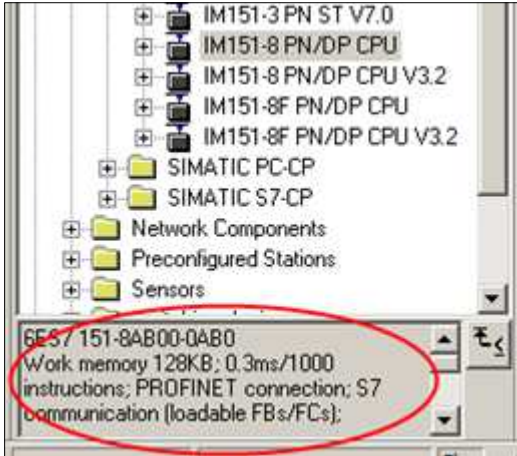

Some CPUs are modules that will require a generic rack to be added prior. If your PLC requires a rack, you will be prompted to add the rack prior to being allowed to insert the CPU module.

After the CPU is added, a popup dialog will prompt the Properties relating to the IP information.

Select **Ethernet(1)** on the bottom list box and enter the correct IP address of the CPU.

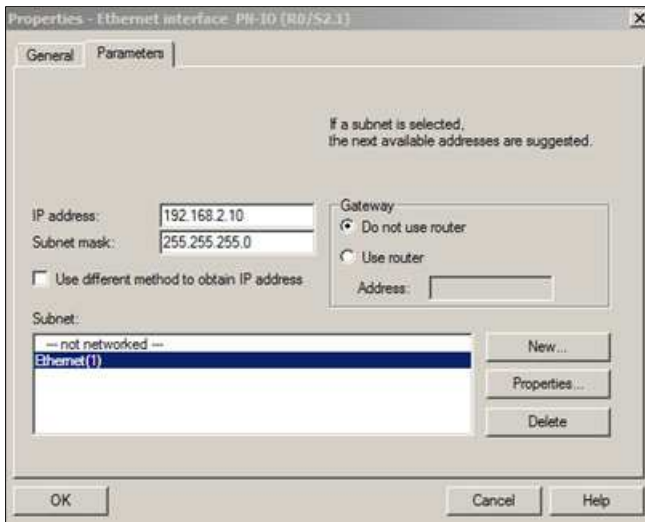

Once the CPU has been added, add any additional expansion modules, if installed. Click the CPU on the left pane and the bottom pane will list the available ports and slots.

Add the camera in the location (**PROFINET I/O > Additional Field Devices > General > di-soric**). The camera can be added by drag and drop to **Ethernet(1): PROFINET-I/O System (100)** or by selecting the **Ethernet(1)** line first and double-clicking the camera. Once the camera has been added the icon will appear on the configuration dialog.

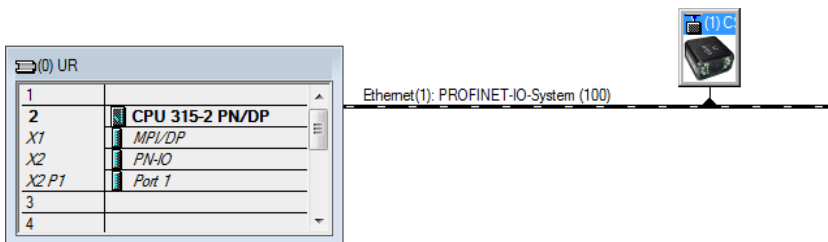

Once the camera has been added, double-click the icon to open the properties dialog. Under the device name, enter the existing name of the camera or a unique name.

Properties - CS501898f5

General | Identification

Short description: CS50
di-soric CS50

Order No./firmware: CS-50-BM2-x-ES-Gx
Family: Smart Camera

Device name: CS501898f5

GSD file: GSDML-V2.32-di-soric-CS50-20160926.xml
Change Release Number...

Node in PROFINET IO System

Device number: 1 PROFINET-IO-System (100)

IP address: 10.20.1.234 Ethernet...

Assign IP address via IO controller

Comment:

OK Cancel Help

If a unique name is used, the device has to be manually updated. View Updating camera name section.

Click the camera icon and the data slot address mapping will be displayed below. Take note of the address values since they will be needed in the demo application. Since there is an infinite combination of modules and slot configurations, the addressing is unique to every setup.

SIMATIC 300(1) (Configuration) -- di-soricblob

(0) UR

Slot	M.	Order number	I address	Q address	Diagnostic address:	Comment
0	CS50	CS50-BM2-x-E			2043*	
X1	Interf				2042*	
X1	Port 1				2041*	
1	Status		0...1			
2	Control			0...1		
3	Echo		264...265			
4	Echo			264...265		
5	Cmd A		256...259			
6	Cmd B			260...263		
7	Cmd A		260...263			
8	Cmd A			256...259		
9	Status		266			
10						
11						
12						
13						
14						
15	Int In		267...286			
16						

(1) CS501898f5

This demo uses the Boolean **In** and **Float In** for data. To the right under **PROFINET I/O CS50 Sensor**, click on **Boolean In**. This will highlight its appropriate slot. Drag and drop this to the highlighted slot. Repeat this for the Float In. The table should now appear as shown below.

Hardware Configuration (0) UR:

1	
2	CPU 315-2 PN/DP
X1	MPI/DP
X2	PN-IO
X2 P1	Port 1
3	
4	

PROFINET-I/O-System (100)

Configuration (1) CS501898f5:

Slot	M.	Order number	I address	Q address	Diagnostic address:	Comment
0	CS50	CS50-BM2-x-E			2043*	
X1	Interf				2042*	
X1	Port 1				2041*	
1	Status		0...1			
2	Control			0...1		
3	Echo		264...265			
4	Echo			264...265		
5	Cmd A		256...259			
6	Cmd B			260...263		
7	Cmd A		260...263			
8	Cmd A			256...259		
9	State		266			
10						
11						
12						
13						
14						
15	Int In		267...286			
16						

Once the hardware configuration has been completed, it's time to compile and download. Click the compile and save icon on the ribbon. If there are any configuration conflicts, the application will prompt a warning at this point.

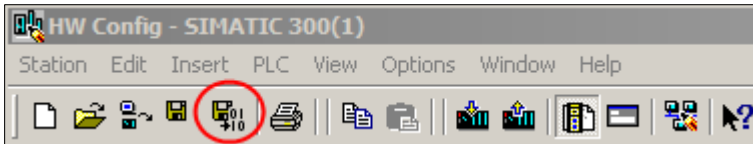

Once compiled, click the download icon on the ribbon to send the information to the PLC.

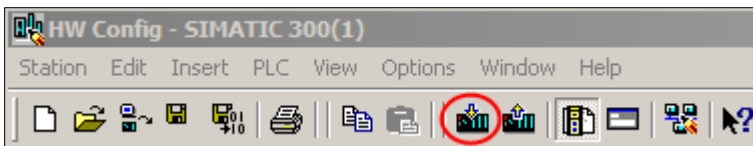

At this point close or minimize the **HW Config** dialog and re-visit the **SIMATIC Manager** dialog. The CPU should be added next to the Hardware icon and in the tree view in the left pane. Expand the CPU tree item and remaining child items below it.

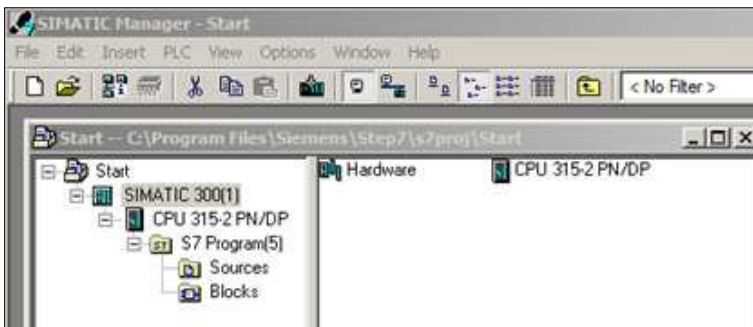

Click the Blocks node to view the program objects.

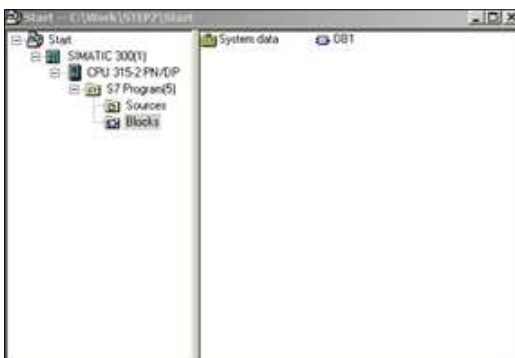

Updating Camera Name

From the HW Config dialog open **Edit Ethernet Node** from the menu item **PLC > Ethernet > Edit Ethernet Node**. From the SIMATIC Manager dialog open Edit Ethernet Node from the menu item **PLC > Edit Ethernet Node**.

Click the **Browse** button to open the node selection dialog.

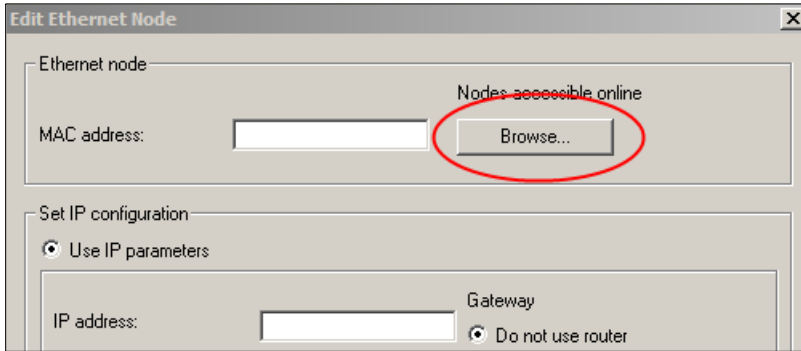

Select the camera and click the **OK** button.

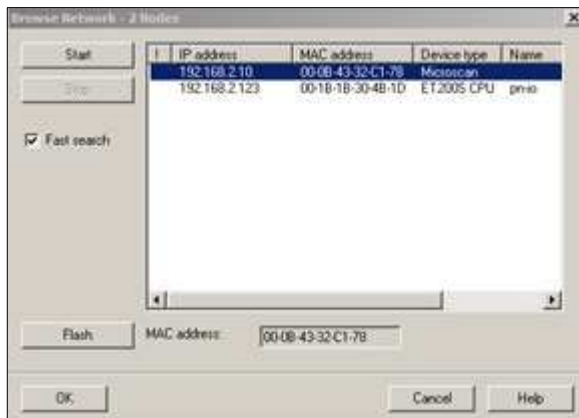

Edit the **Device Name**, if necessary, to match the name entered previously in the CS50 Sensor properties dialog, and click the **Assign Name** button.

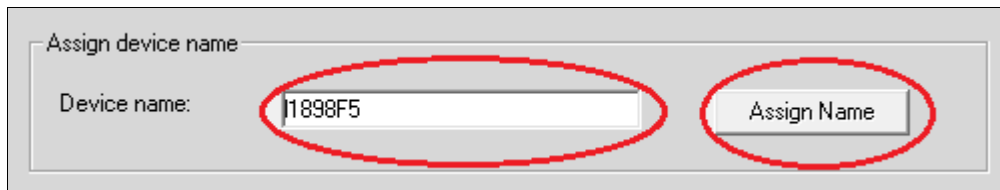

Importing Example Program

From the SIMATIC Manager, open the example program from the menu **File > Open**. Click the **Browse** button to locate the (BlobDemo) program. The BlobDemo is located in `\di-soric\Vscape\Tutorials and Samples\CS50 Sensor\PROFINET Demo\Step7_Demos\Circle_LocatorDemo\S7Circle_LocatorDemo\Circle_LocatorDemo.s7p`.

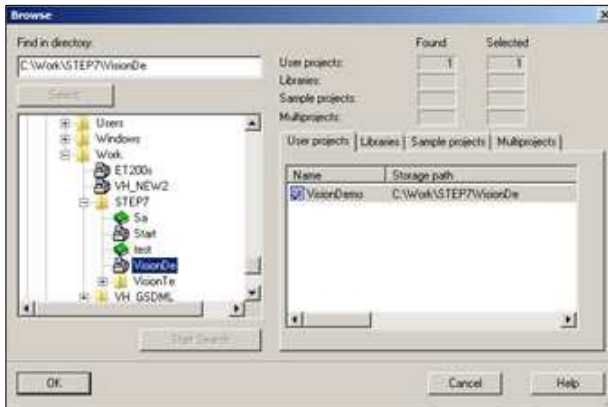

Split both example and current projects in the dialog as shown.

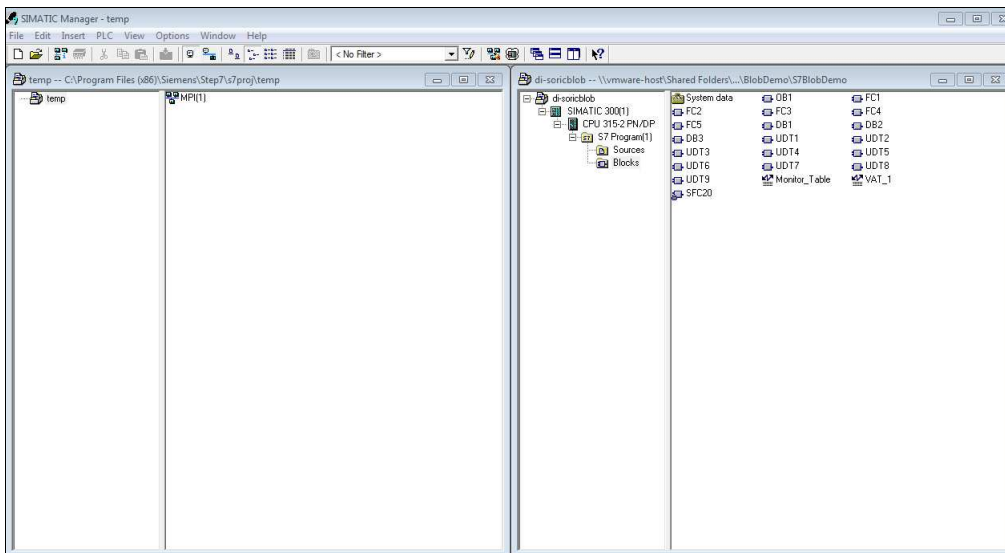

Select the objects minus the **System** data object and copy with a right-click and Copy or CTRL + C. Paste into the current project with a right-click > paste or CTRL + V. When prompted that **OB1** already exists, click the **Yes** button to overwrite it. Now the example program is imported to the current project.

Select the **Blocks** icon on the left pane. Then click the download button on the top ribbon. This will download the new copied functions and system data to the PLC. Now it's time to update the new addressing from the hardware installation prior. Double-click the **OB1** block to open the **LAD/STL/FBD** editor. OB1 is the main routine of the PLC program.

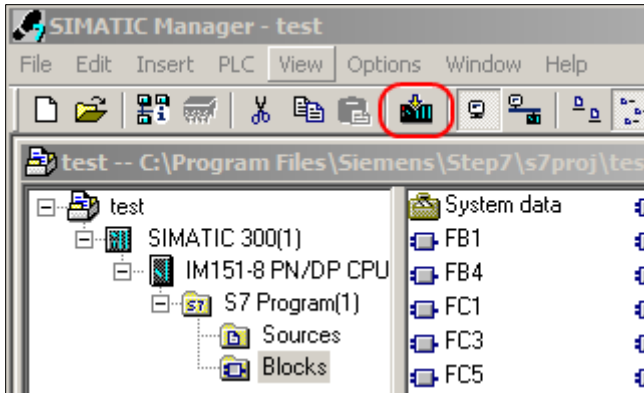

Scroll down to **Network 1**. This is where the data is mapped from the camera to the local data structure. **FC1** is a function that pushes the input data from the camera to the program structure. Click the numbers to match the address on the hardware as shown. Click the following buttons on the popup dialogs:

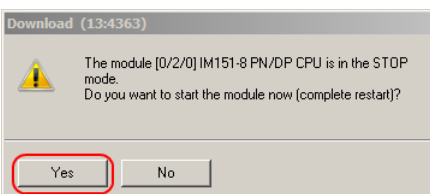
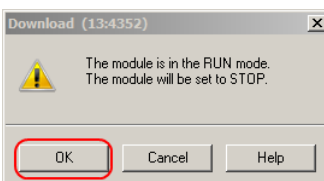
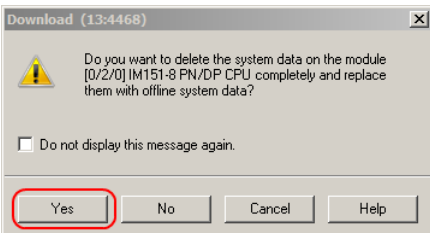
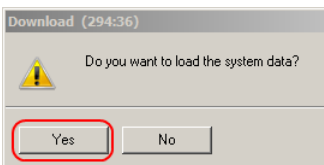
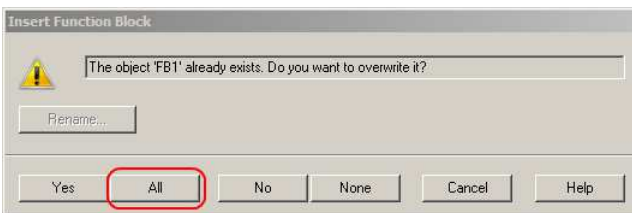
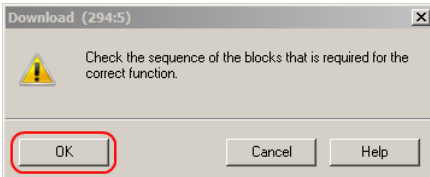

Note: This is the address mapping view of the CS50 Sensor module which is derived from the hardware config view.

	Slot	Module	Order number	I address	Q address	Diagnost
	0	CS50189815	CS50-BM2-x-E			2043"
	X1	Interface				2042"
	X1	Port 1				2041"
0	1	Status		0..1		
	2	Control			0..1	
264	3	Echo In		264...265		
	4	Echo Out			264...265	
256	5	Cmd Code Ret		256...259		
	6	Cmd Code			260...263	
260	7	Cmd Ret		260...263		
	8	Cmd Arg			256...259	
266	9	State		266		
	10					
0	11					
	12					
264	13					
	14					
260	15	Int In		267...286		
256	16					

The addresses on the right must be copied to **Network 1** to match. Ex: HW config shows Status as address 0..1. Copy **0** into Network 1, **STATUS** value.

Repeat the same steps for **Network 6** to update the output data mapping. Keep in mind that all input addresses are under the (**I address**) column and the output addresses are under the (**Q address**) column. Save to the PC and download to the PLC.

Do a master reset and set the PLC to RUN mode. Make sure all LEDs indicate **good**.

Running the Demo

In the **SIMATIC Manager** dialog, double-click the **VAT_1** icon. This will open the variable table dialog for the data type demo. Maximize the internal dialog to increase the viewing area.

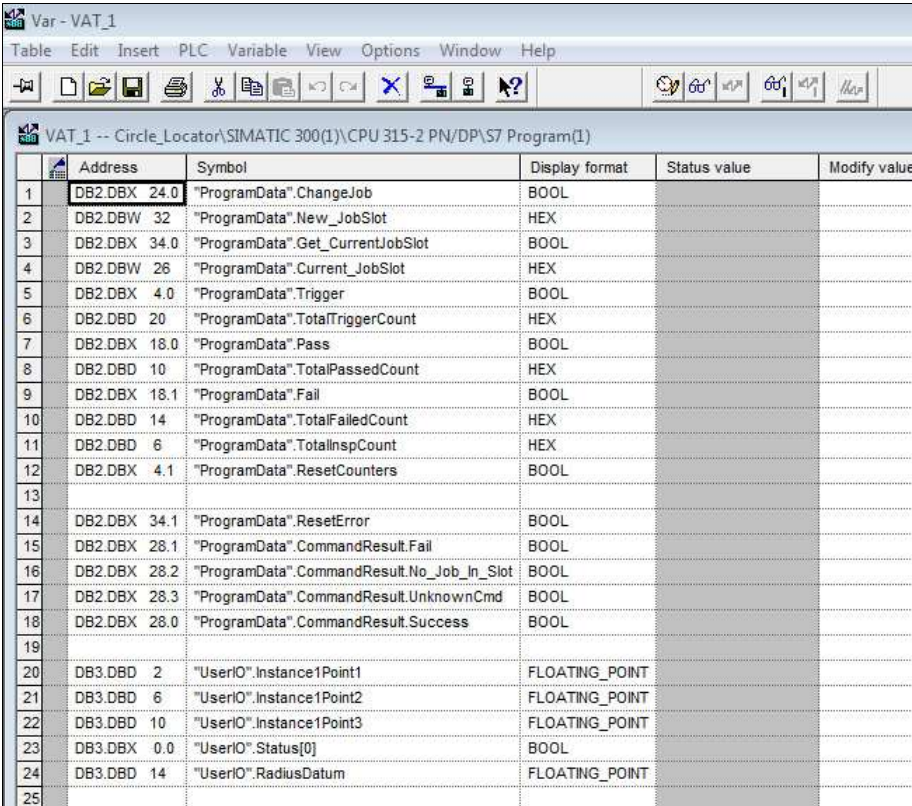

	Address	Symbol	Display format	Status value	Modify value
1	DB2.DBX 24.0	"ProgramData".ChangeJob	BOOL		
2	DB2.DBW 32	"ProgramData".New_JobSlot	HEX		
3	DB2.DBX 34.0	"ProgramData".Get_CurrentJobSlot	BOOL		
4	DB2.DBW 26	"ProgramData".Current_JobSlot	HEX		
5	DB2.DBX 4.0	"ProgramData".Trigger	BOOL		
6	DB2.DBD 20	"ProgramData".TotalTriggerCount	HEX		
7	DB2.DBX 18.0	"ProgramData".Pass	BOOL		
8	DB2.DBD 10	"ProgramData".TotalPassedCount	HEX		
9	DB2.DBX 18.1	"ProgramData".Fail	BOOL		
10	DB2.DBD 14	"ProgramData".TotalFailedCount	HEX		
11	DB2.DBD 6	"ProgramData".TotalInspCount	HEX		
12	DB2.DBX 4.1	"ProgramData".ResetCounters	BOOL		
13					
14	DB2.DBX 34.1	"ProgramData".ResetError	BOOL		
15	DB2.DBX 28.1	"ProgramData".CommandResult.Fail	BOOL		
16	DB2.DBX 28.2	"ProgramData".CommandResult.No_Job_In_Slot	BOOL		
17	DB2.DBX 28.3	"ProgramData".CommandResult.UnknownCmd	BOOL		
18	DB2.DBX 28.0	"ProgramData".CommandResult.Success	BOOL		
19					
20	DB3.DBD 2	"UserIO".Instance1Point1	FLOATING_POINT		
21	DB3.DBD 6	"UserIO".Instance1Point2	FLOATING_POINT		
22	DB3.DBD 10	"UserIO".Instance1Point3	FLOATING_POINT		
23	DB3.DBX 0.0	"UserIO".Status[0]	BOOL		
24	DB3.DBD 14	"UserIO".RadiusDatum	FLOATING_POINT		
25					

To establish a live connection to the PLC, click the **Monitor Variable** button on the ribbon. This will update data from the PLC to the dialog. The top title bar will go blue and the bottom status will show run with a green progress bar.

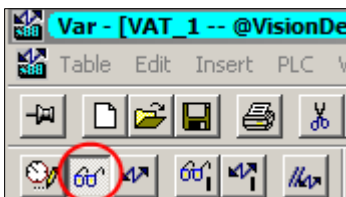

The following operations can be tried here:

Change Job	Switch jobs from one slot to another
Get Current Job Slot	Displays the slot of the currently running job
Trigger an Inspection	Causes the camera to cycle through its inspection.
Reset Counters	Resets the TotalTriggerCount, TotalPassedCount, TotalFailedCount, and TotalInspCount to 0, and also sends a command to the camera to reset its internal counters.
Reset an Error condition	If an error occurs during run time, this will reset it, so demo may be continued.

Change Jobs + Get Current Job Slot

Be sure to follow instructions in the CS50 Software Setup section to store a job in a slot in the camera memory. To properly execute this test, load another job into **slot 2** of the camera. For example, the Circle_LocatorDemo job. CS50 Software must be closed to run this Demo.

Using the VAT_1 elements **ChangeJob** and **New_JobSlot**. Click the **Modify value** column next to **New_JobSlot**, type 2, and type **Enter**. Click on the Modify Value column to the right of **ChangeJob** and enter TRUE. Click the icon indicated at the top.

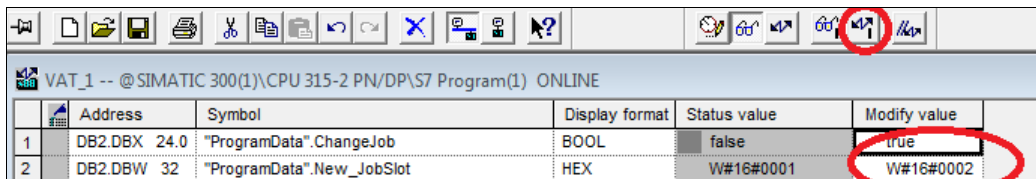

	Address	Symbol	Display format	Status value	Modify value
1	DB2.DBX 24.0	"ProgramData".ChangeJob	BOOL	false	true
2	DB2.DBW 32	"ProgramData".New_JobSlot	HEX	W#16#0001	W#16#0002

The current job will be changed to the job in **slot 2**. To verify this, clear all changes made to the **Modify value** column, and click **Modify value** to the right of **Get_CurrentJobSlot**. Enter **TRUE**, and click on the indicated icon again.

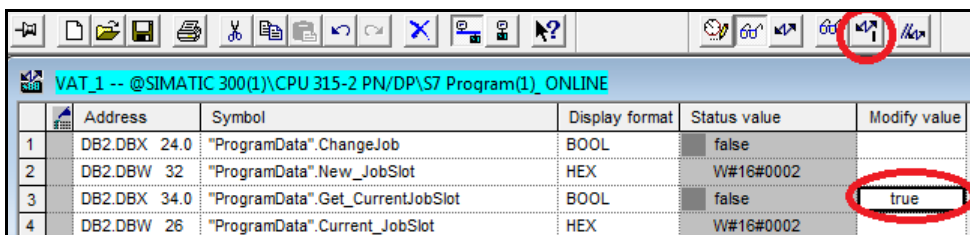

	Address	Symbol	Display format	Status value	Modify value
1	DB2.DBX 24.0	"ProgramData".ChangeJob	BOOL	false	
2	DB2.DBW 32	"ProgramData".New_JobSlot	HEX	W#16#0002	
3	DB2.DBX 34.0	"ProgramData".Get_CurrentJobSlot	BOOL	false	true
4	DB2.DBW 26	"ProgramData".Current_JobSlot	HEX	W#16#0002	

You will see the current job listed to the right of **Current_JobSlot**. You may repeat this procedure changing the slot back to **1** and verify the current job slot is now **1**.

Trigger an Inspection and Reset Counters

Be sure the current job selected is **slot 1**. Clear any changes made to the **Modify value** column. If you want to watch the inspection, be sure CS50 Software is running, and connected to the device. Be sure the job is running. If you choose not to run CS50 Software, you may look at the LEDs on the device to confirm your triggers. Change the value to the right of Trigger to **TRUE**, and click the indicated icon.

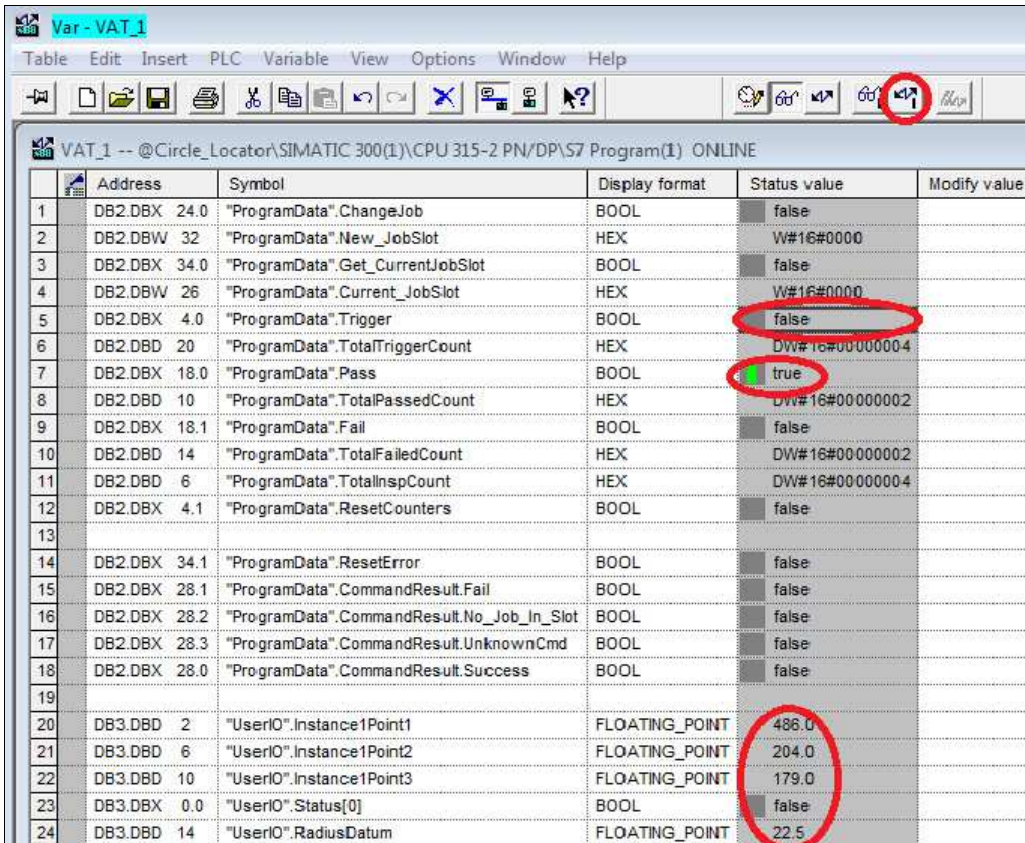

	Address	Symbol	Display format	Status value	Modify value
1	DB2.DBX 24.0	"ProgramData".ChangeJob	BOOL	false	
2	DB2.DBW 32	"ProgramData".New_JobSlot	HEX	W#16#0000	
3	DB2.DBX 34.0	"ProgramData".Get_CurrentJobSlot	BOOL	false	
4	DB2.DBW 26	"ProgramData".Current_JobSlot	HEX	W#16#0000	
5	DB2.DBX 4.0	"ProgramData".Trigger	BOOL	false	
6	DB2.DBW 20	"ProgramData".TotalTriggerCount	HEX	DW#16#00000004	
7	DB2.DBX 18.0	"ProgramData".Pass	BOOL	true	
8	DB2.DBW 10	"ProgramData".TotalPassedCount	HEX	DW#16#00000002	
9	DB2.DBX 18.1	"ProgramData".Fail	BOOL	false	
10	DB2.DBW 14	"ProgramData".TotalFailedCount	HEX	DW#16#00000002	
11	DB2.DBW 6	"ProgramData".TotalInspCount	HEX	DW#16#00000004	
12	DB2.DBX 4.1	"ProgramData".ResetCounters	BOOL	false	
13					
14	DB2.DBX 34.1	"ProgramData".ResetError	BOOL	false	
15	DB2.DBX 28.1	"ProgramData".CommandResult.Fail	BOOL	false	
16	DB2.DBX 28.2	"ProgramData".CommandResult.No_Job_In_Slot	BOOL	false	
17	DB2.DBX 28.3	"ProgramData".CommandResult.UnknownCmd	BOOL	false	
18	DB2.DBX 28.0	"ProgramData".CommandResult.Success	BOOL	false	
19					
20	DB3.DBW 2	"UserIO".Instance1Point1	FLOATING_POINT	486.0	
21	DB3.DBW 6	"UserIO".Instance1Point2	FLOATING_POINT	204.0	
22	DB3.DBW 10	"UserIO".Instance1Point3	FLOATING_POINT	179.0	
23	DB3.DBX 0.0	"UserIO".Status[0]	BOOL	false	
24	DB3.DBW 14	"UserIO".RadiusDatum	FLOATING_POINT	22.5	

You will see various changes as shown above. The pass and fail bools will indicate whether the inspection has passed or failed. Also, the appropriate counters will have incremented. Each click of the icon will cause an inspection which will bounce from one image to the next. One will pass and the next will fail.

Reset Counters

To reset the counters, clear all settings in the Modify value column, change the one next to **ResetCounters** to **TRUE**, and click the icon again. You will see all the counters in blue reset to 0.

Address	Symbol	Display format	Status value	Modify value	
1	DB2.DBX 24.0	"ProgramData".ChangeJob	BOOL	false	
2	DB2.DBW 32	"ProgramData".New_JobSlot	HEX	W#16#0000	
3	DB2.DBX 34.0	"ProgramData".Get_CurrentJobSlot	BOOL	false	
4	DB2.DBW 26	"ProgramData".Current_JobSlot	HEX	W#16#0000	
5	DB2.DBX 4.0	"ProgramData".Trigger	BOOL	false	
6	DB2.DBD 20	"ProgramData".TotalTriggerCount	HEX	DW#16#00000000	
7	DB2.DBX 18.0	"ProgramData".Pass	BOOL	true	
8	DB2.DBD 10	"ProgramData".TotalPassedCount	HEX	DW#16#00000000	
9	DB2.DBX 18.1	"ProgramData".Fail	BOOL	false	
10	DB2.DBD 14	"ProgramData".TotalFailedCount	HEX	DW#16#00000000	
11	DB2.DBD 6	"ProgramData".TotalInspCount	HEX	DW#16#00000000	
12	DB2.DBX 4.1	"ProgramData".ResetCounters	BOOL	false	true
13					
14	DB2.DBX 34.1	"ProgramData".ResetError	BOOL	false	
15	DB2.DBX 28.1	"ProgramData".CommandResult.Fail	BOOL	false	
16	DB2.DBX 28.2	"ProgramData".CommandResult.No_Job_In_Slot	BOOL	false	
17	DB2.DBX 28.3	"ProgramData".CommandResult.UnknownCmd	BOOL	false	
18	DB2.DBX 28.0	"ProgramData".CommandResult.Success	BOOL	false	
19					
20	DB3.DBD 2	"UserIO".Instance1Point1	FLOATING_POINT	486.0	
21	DB3.DBD 6	"UserIO".Instance1Point2	FLOATING_POINT	204.0	
22	DB3.DBD 10	"UserIO".Instance1Point3	FLOATING_POINT	179.0	
23	DB3.DBX 0.0	"UserIO".Status[0]	BOOL	false	
24	DB3.DBD 14	"UserIO".RadiusDatum	FLOATING_POINT	22.5	
25					

If you clear this again and set the Trigger to **TRUE**, and click the lightning bolt button again, you will notice that the counts start at **1** on both the PLC counters and CS50 Software counters.

Reset Error

If at any time there is an error indicated by a TRUE in any of the values below, you can clear the error by entering a TRUE to the right of **ResetError** and clicking the icon. Reset it to **FALSE** and click the button again. Any errors in the values below should be cleared.

DB2.DBX 28.1	"ProgramData".CommandResult.Fail	BOOL	false
DB2.DBX 28.3	"ProgramData".CommandResult.UnknownCmd	BOOL	false
DB2.DBX 28.0	"ProgramData".CommandResult.Success	BOOL	false